

Optical bias selector based on a multilayer a-SiC:H optical filter

ACKNOWLEDGEMENTS

- FCT – ref. UID/EEA/00066/2013

- We demonstrate an integrated VIS-NIR optical filter based on SiC technology.

- The concept is extended to implement a 1 x 5 WDM in the VIS-NIR range.



- Coder/decoder device
 I_R /RGBV/UV channels;
 30kbps

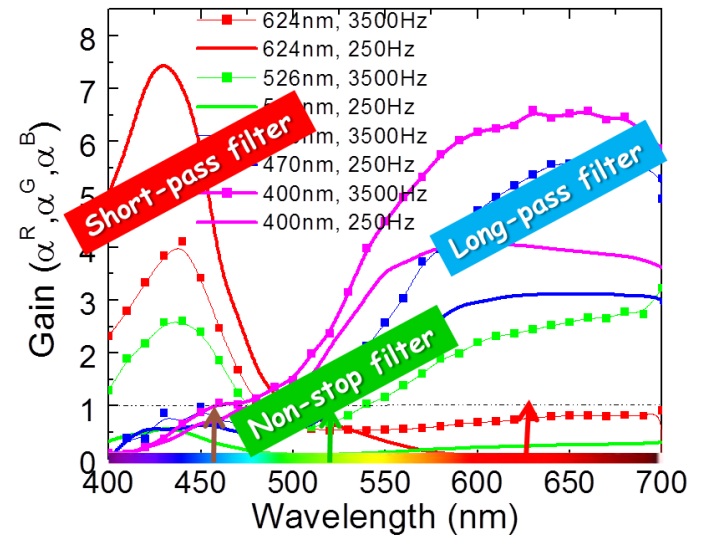
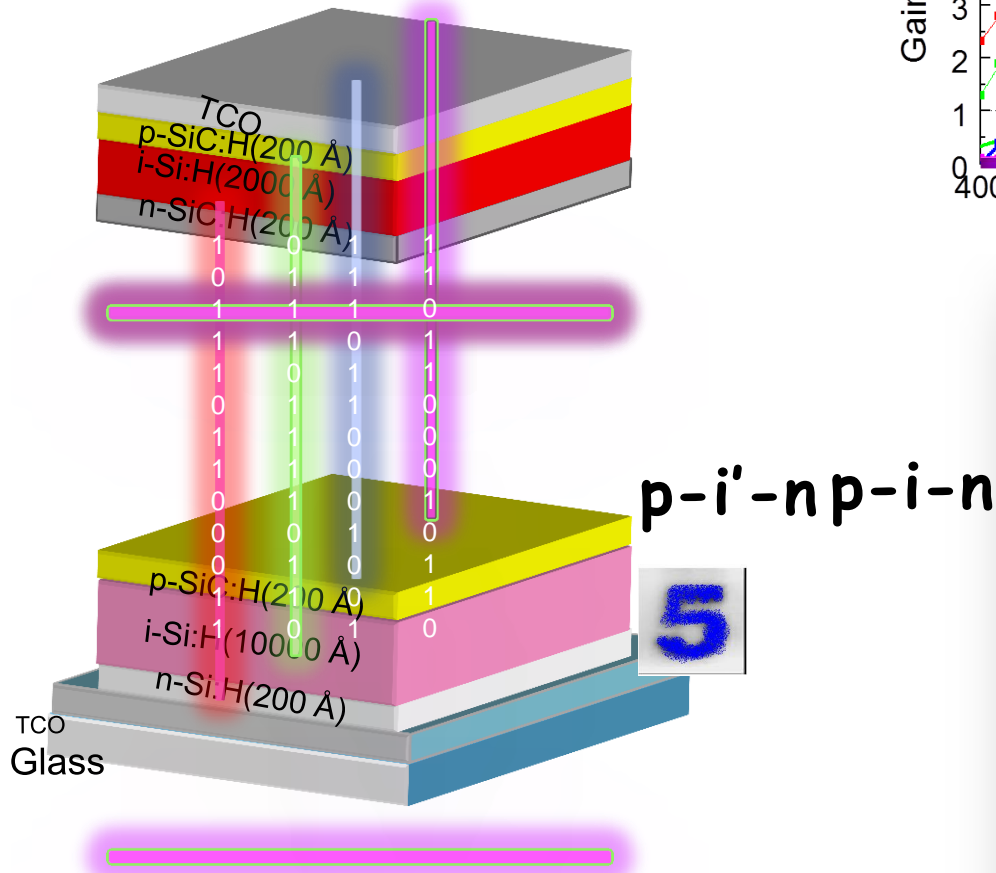

- Light-to-dark sensitivity depends on the carbon concentration
- Color recognition depends on the applied bias
- Light filtering depends on the bias wavelength and side
- WDM device
RGB channels; 6000bps

Device configuration and operation

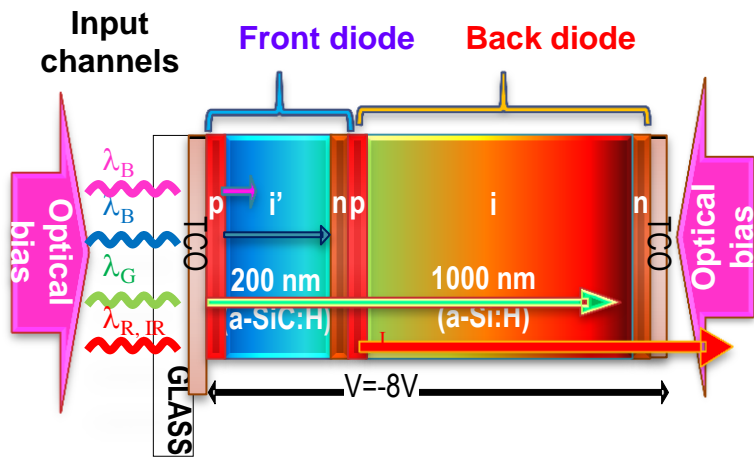

- Produced by PECVD
- The thickness of the front photodiode are optimized for blue collection and red transmittance
- The thickness of the back photodiode was adjusted to achieve high collection in the red spectral range

✓ Both front and back diodes act as optical filters confining, respectively, the blue and the red optical carriers, while the green ones are absorbed across both.

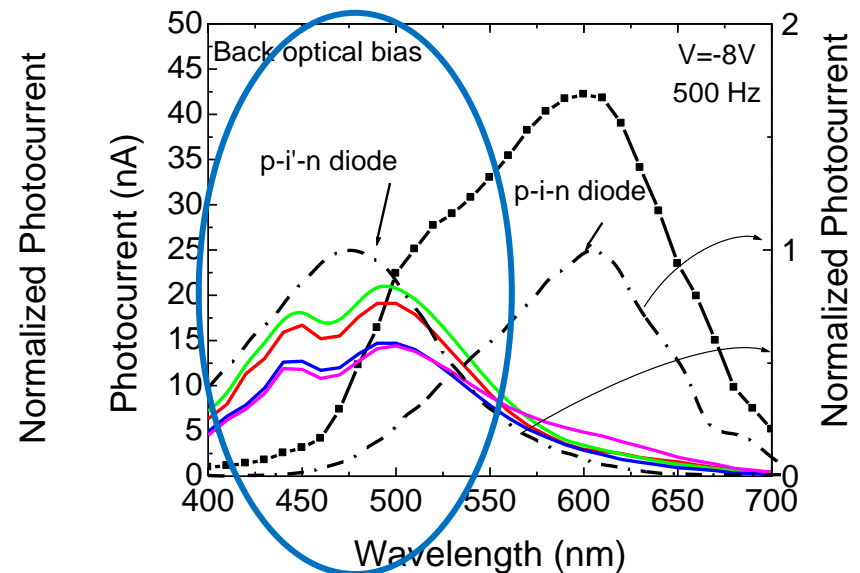
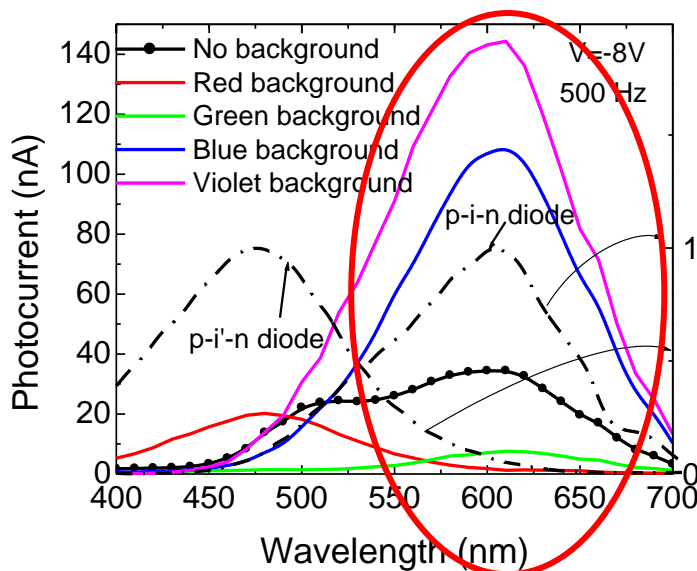

Optical bias filtering effects

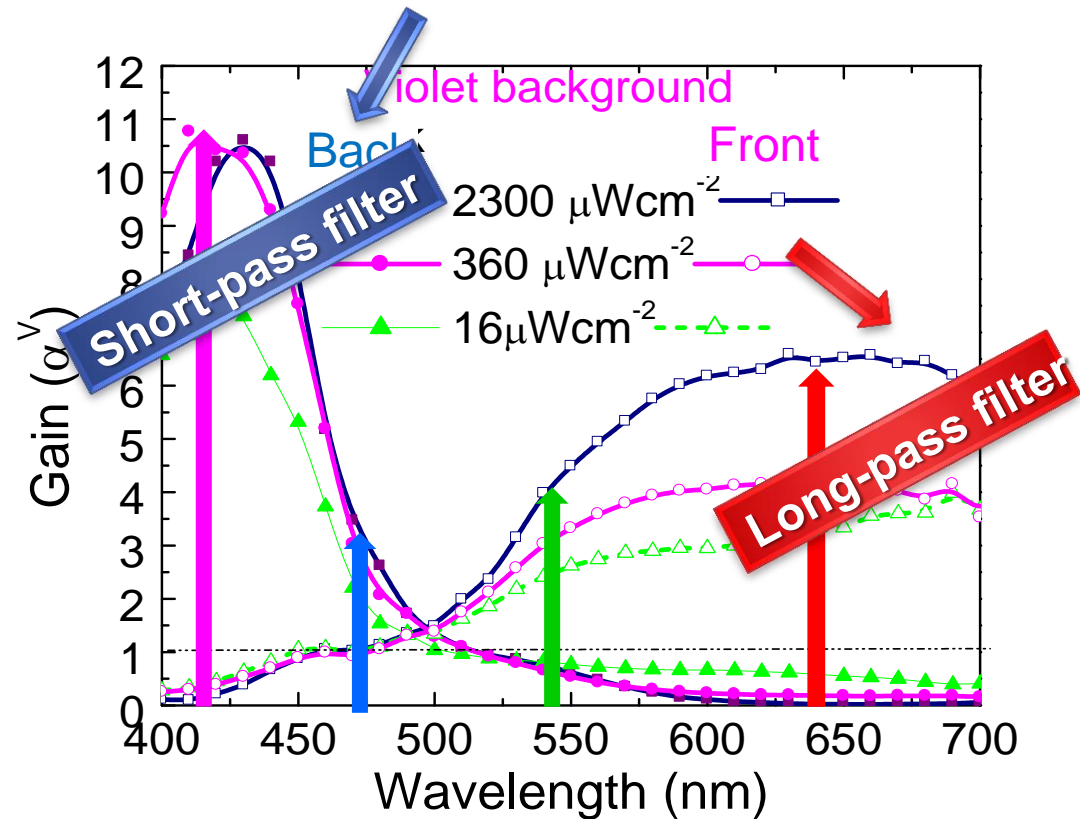
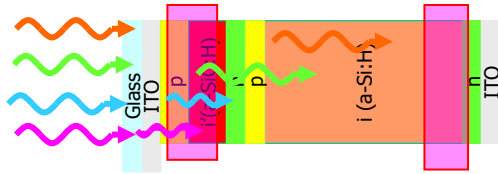

✓ The device acts as an active long-pass filter under front irradiation and a low-pass filter under back irradiation.

- By switching the irradiation side the short-, and long- spectral region can be sequentially tuned.
- The medium region (475 nm-530 nm) can only be tuned by using both active filters.

MUX/DEMUX Device

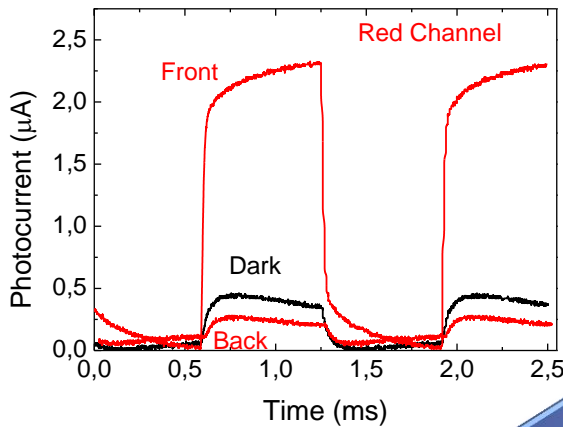
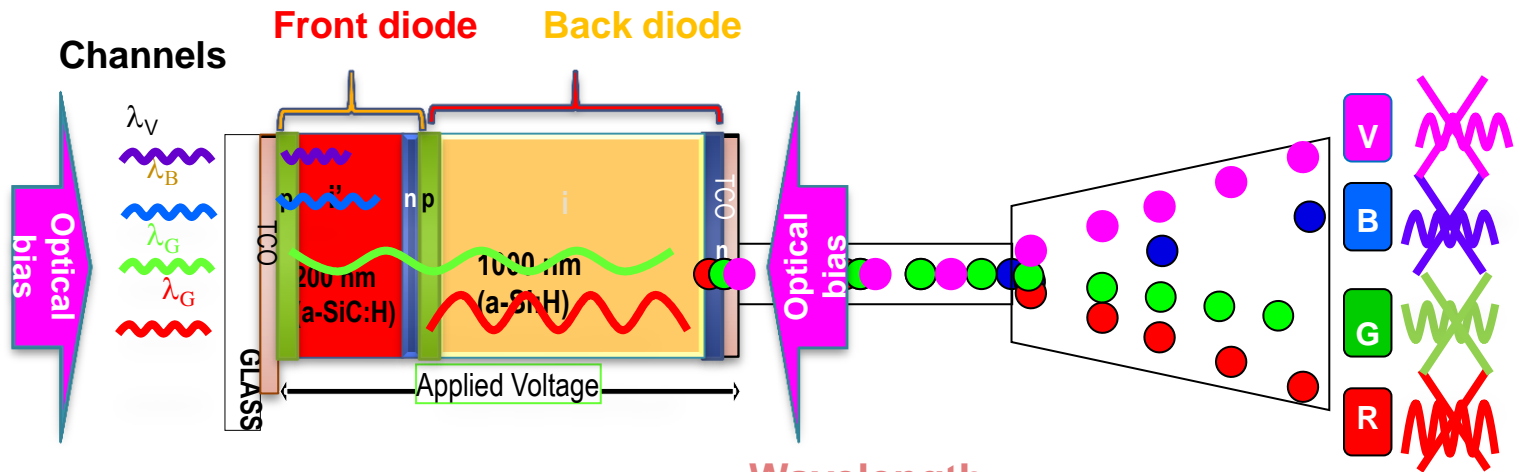

Optical bias control filter

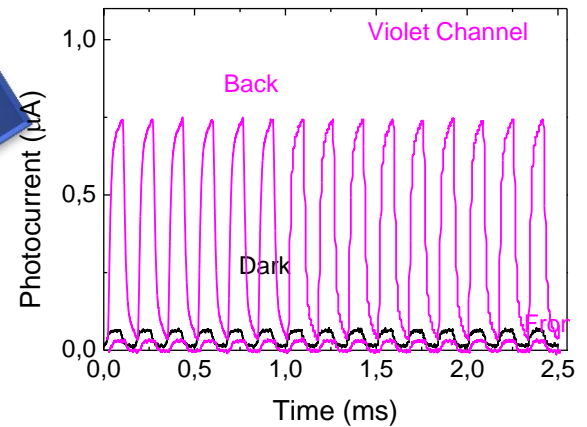

- ✓ The input signals exhibit a nonlinear dependence on the wavelength.
- ✓ Gains ($\alpha^V_{R,G,B,V}$) at the input red, green, blue and violet channels.

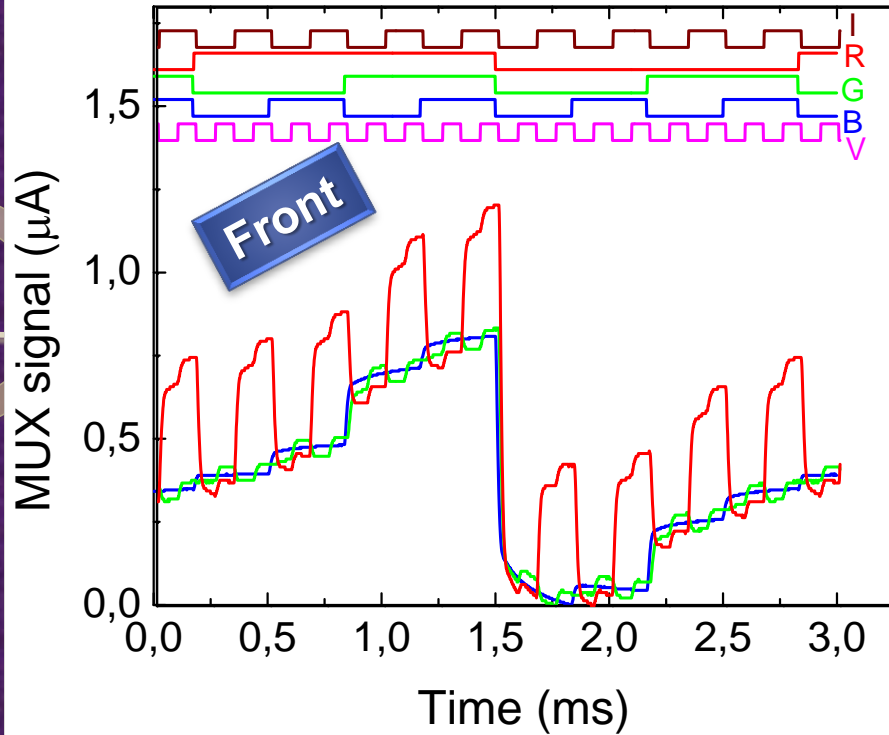

•The output presents 2^4 ordered levels each one related with **RGBV** bit sequences

•The output presents 2^3 ordered levels each one related with **RGB** bit sequences

•The output presents 2^5 ordered levels each one related with **RGBVI** bit sequences

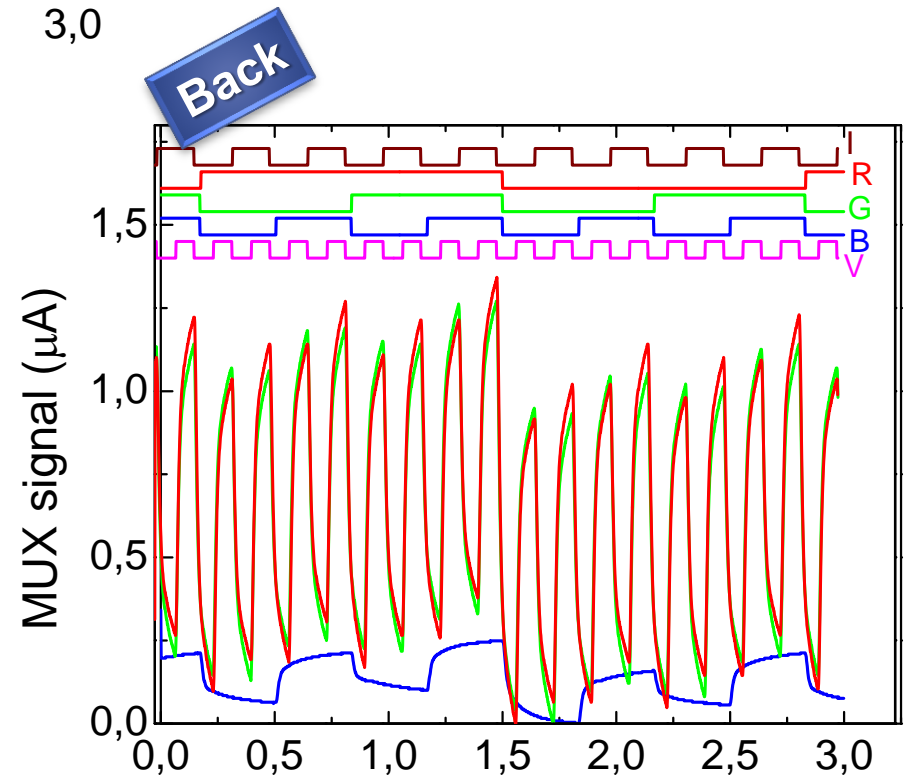

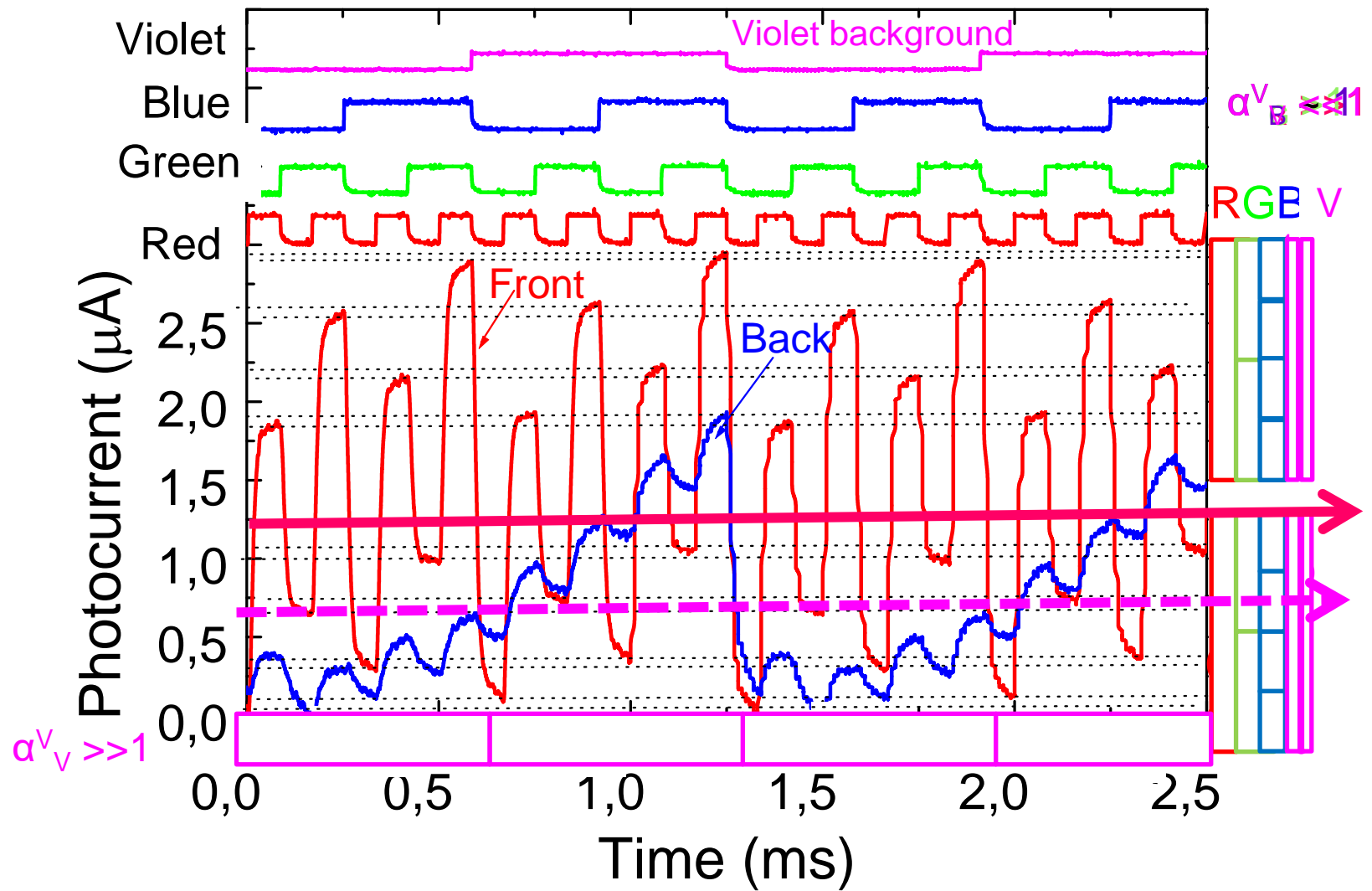

- The output presents 2^4 ordered levels each one related with *RGBV* bit sequences
- The signal magnitude under irradiation is balanced by the amplification factors

Four channels transmission.

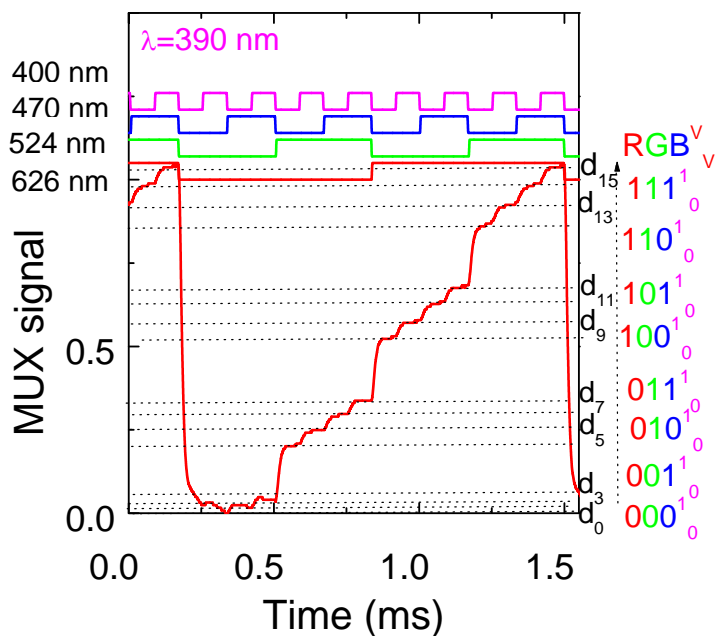

Five channels transmission

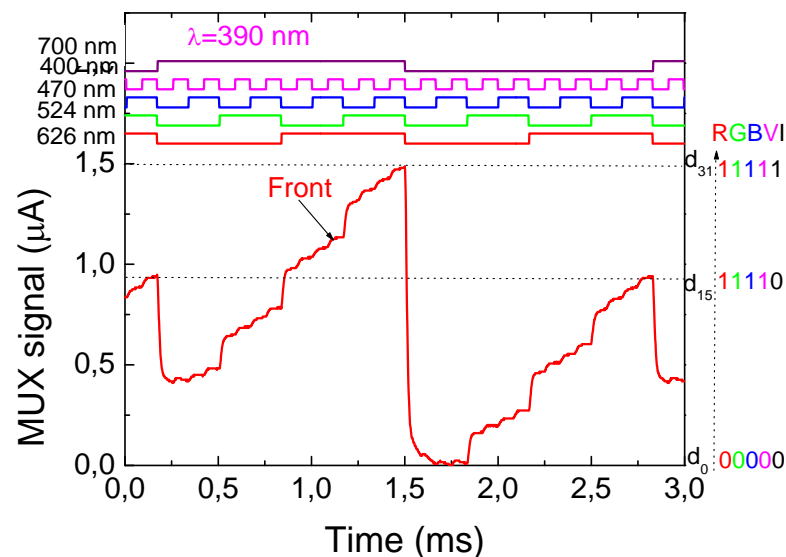

- 2^n ordered levels pondered by their optical gains are detected and correspond to all the possible combinations of the *on/off* states
- The background acts as selector that chooses one or more of the 2^n sublevels, with n the number of transmitted channels, and their n -bit binary code .
- By assigning each output level to a n digit binary code the signal can be decoded. A maximum transmission rate capability of 60 Kbps was achieved in a five channel transmission

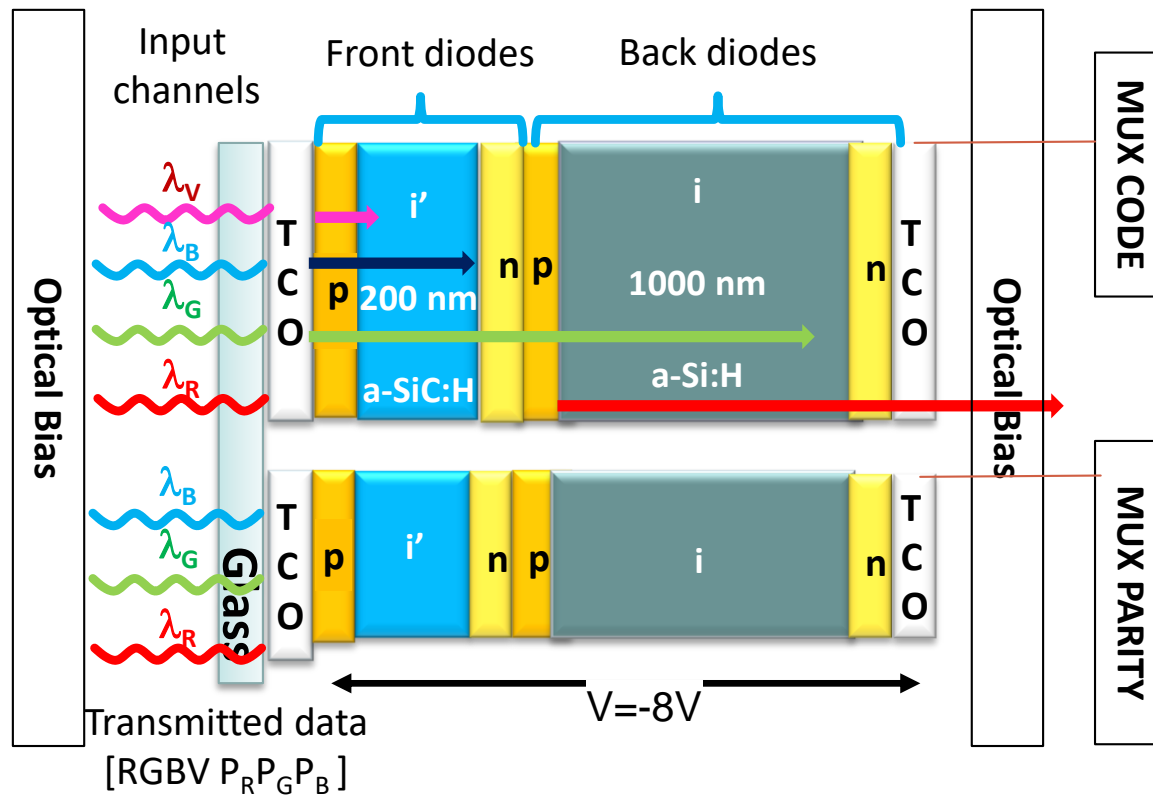

- The proximity of consecutive levels causes occasional errors in the decoded information that should be corrected.
- For parity check, and in a four or five channel transmission, three or four synchronous channels, red, green, blue and violet were read in simultaneous with the data code.

As an application, data was sent through one detector while error detection and correction bits were sent through the other.

The parity bits

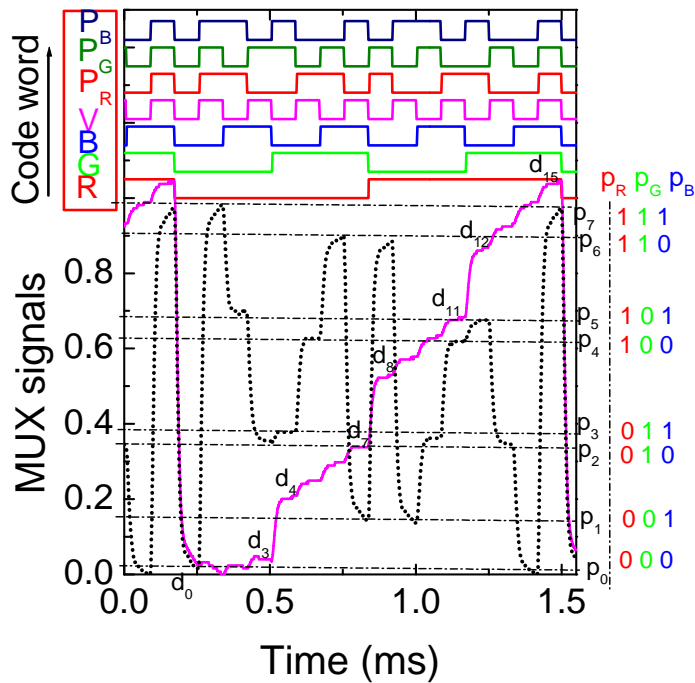

Four channels transmission

$$P_R\text{-}(VRB) = V + R + B$$

$$P_G\text{-}(VRG) = V + R + G$$

$$P_B\text{-}(VGB) = V + G + B$$

$$P_V\text{-}(I) = I$$

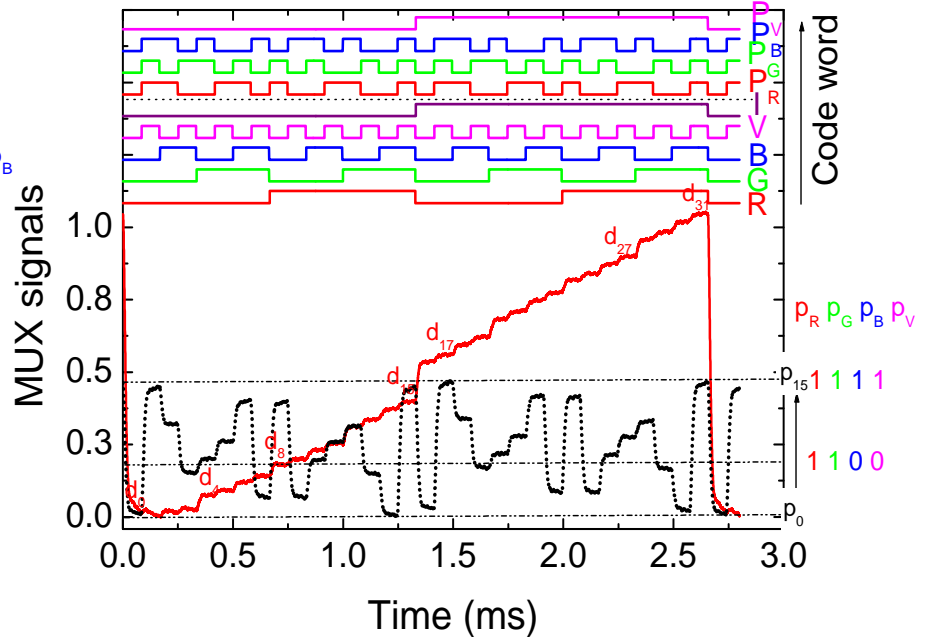

Five channels transmission

The parity bits are SUM bits of the three-bit additions of violet pulsed signal with two additional bits of RGB

one-bit extra

- The parity of the word is checked after reading the word.
- The word is accepted if the parity of the bits read out is correct. If the parity of the bits is incorrect, an error is detected and should be corrected.

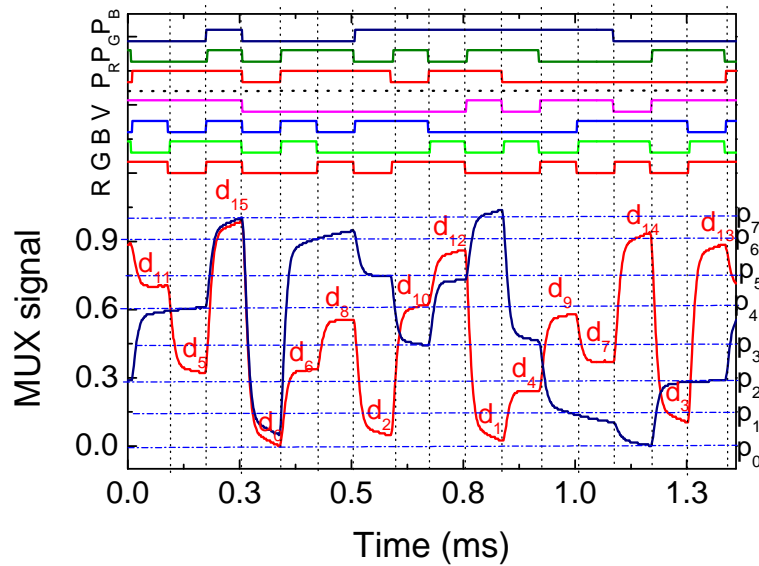

The decoding algorithm is based on a proximity search after each time slot is translated to a vector in multidimensional space.

The vector components are determined by I_1 and I_2 , where I_1 (d levels) and I_2 (p levels) are the currents measured.

The result is then compared with all vectors obtained from a calibration sequence where to each code level, $d(0-31)$, is assigned the correspondent parity level, $p(0-15)$.

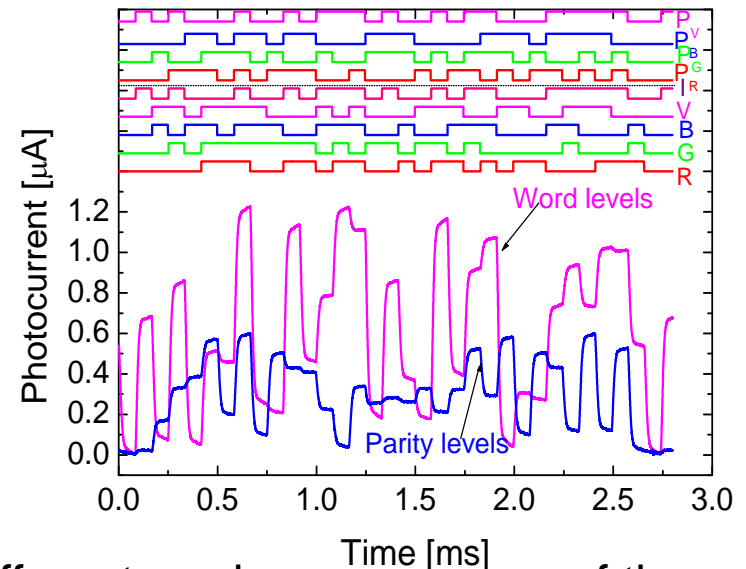

We have tested the algorithm with different random sequences of the channels and we have recovered the original color bits

1 x 5 WDM in the VIS-NIR range

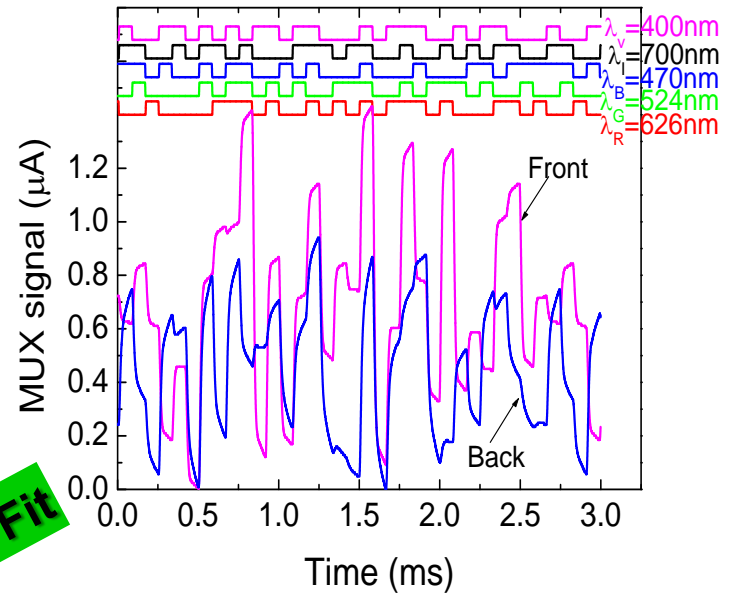
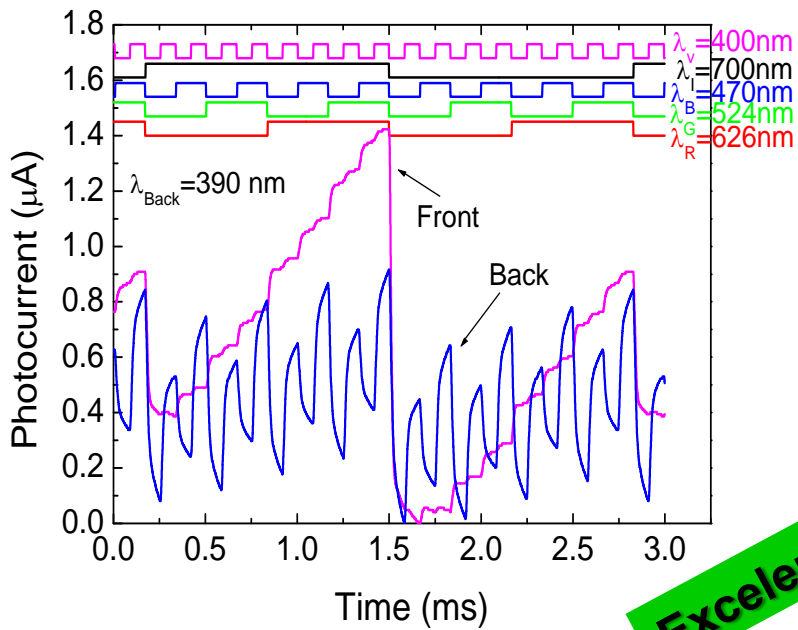

Excellent Fit

- The output presents 2^5 ordered levels each one related with **RGBVI** bit sequences

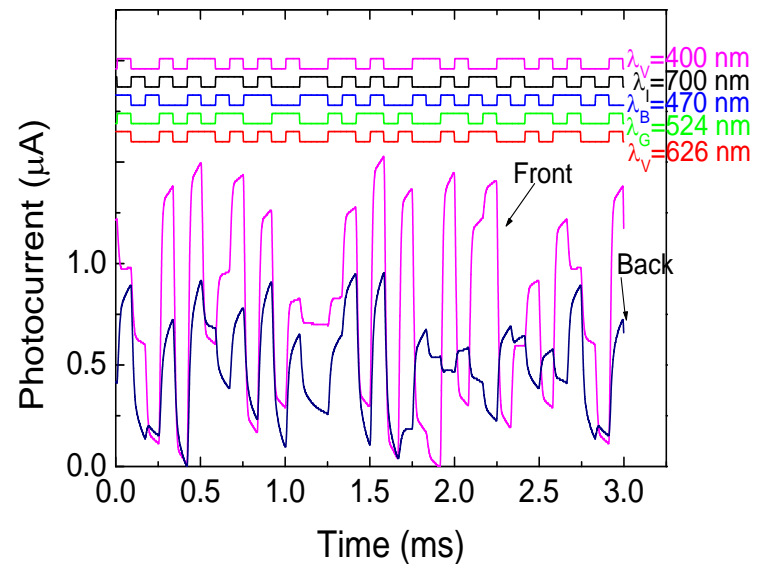
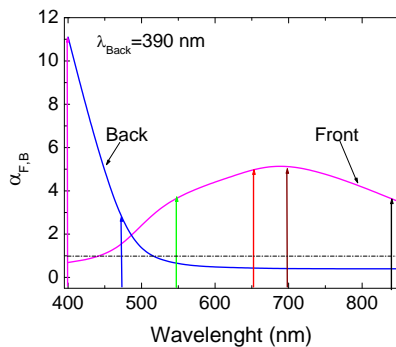

$$i(t) = \begin{bmatrix} 0 & 1 \\ R_2 & 0 \end{bmatrix} v_{1,2}(t)$$

Optoelectronic model

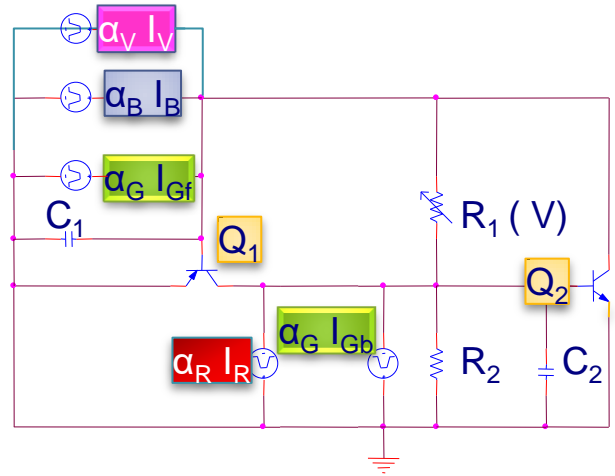
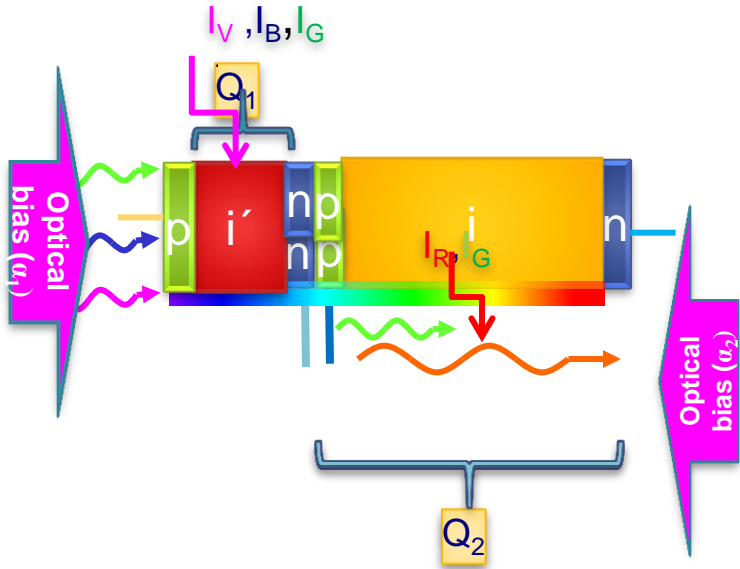

$$\frac{dv_{1,2}}{dt} = \begin{bmatrix} \alpha_1(\alpha_{V,B,G}) \\ C_1 \\ \alpha_2(\alpha_{R,G}) \\ C_2 \end{bmatrix} i_{1,2}(t) + \begin{bmatrix} -\frac{1}{R_1 C_1} & \frac{1}{R_1 C_1} \\ \frac{1}{R_1 C_2} & -\frac{1}{R_1 C_2} - \frac{1}{R_2 C_2} \end{bmatrix} v_{1,2}(t)$$

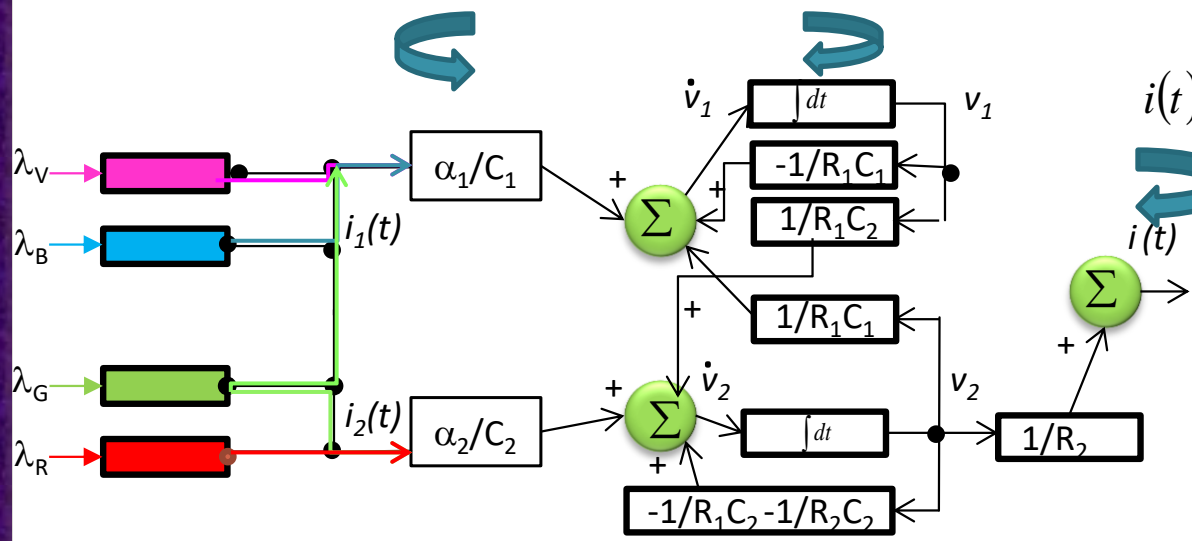

$$i(t) = \begin{bmatrix} 0 & 1 \\ R_2 & 0 \end{bmatrix} v_{1,2}(t)$$

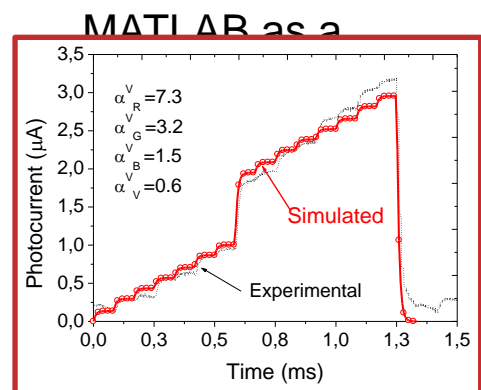

Prediction over relational multiplexed signals

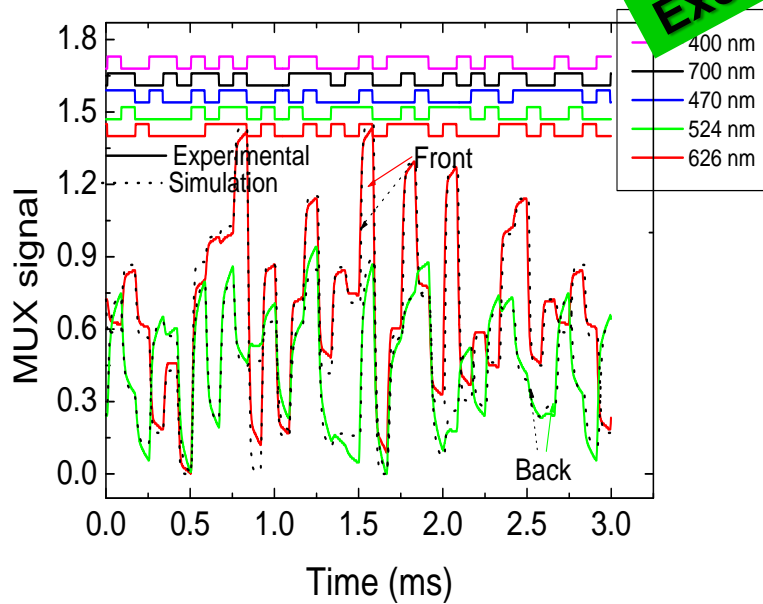
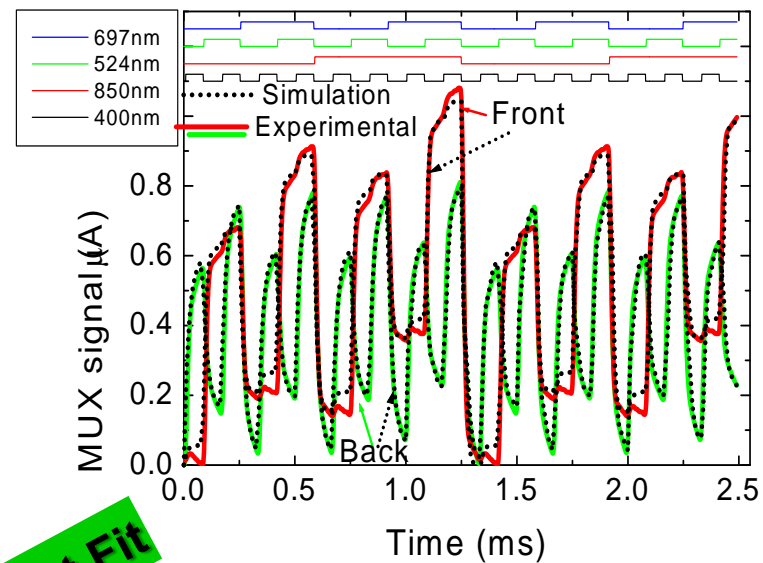
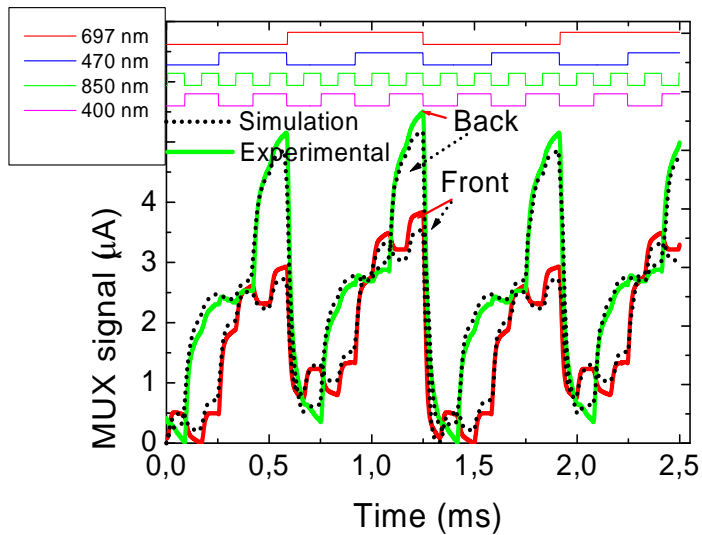

Excellent Fit

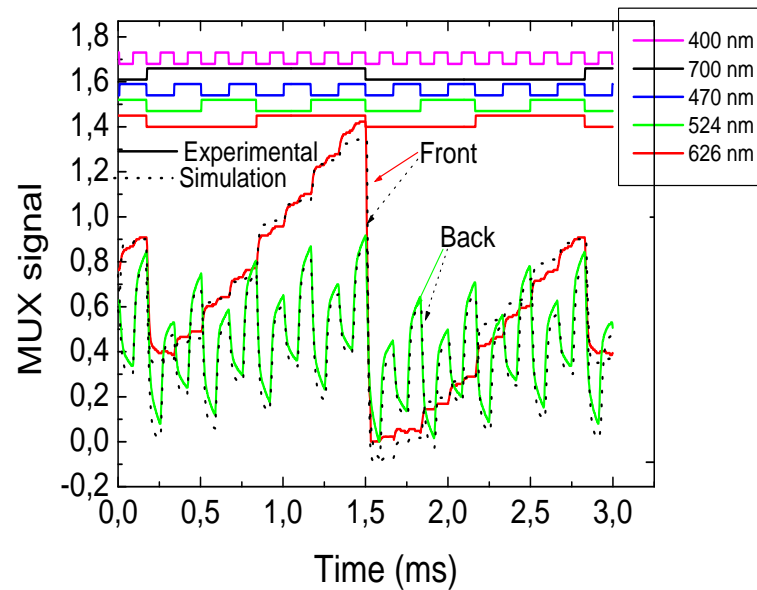

- A a-SiC 1x5 WDM device, with channel separation in the visible range, was presented and its operation as wavelength selector explained.
- Encoding and decoding data was analyzed and the codewords generated using the MUX signals due to the data transmitted together with the check parity bits tested.
- An algorithm to decode the transmitted information was presented. A transmitter capability of 60 kbps using the generated codeword was achieved.

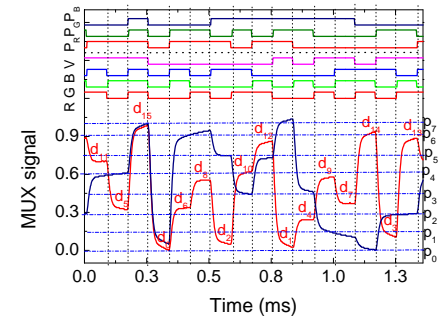
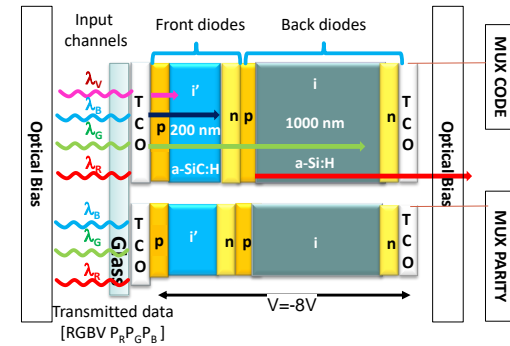
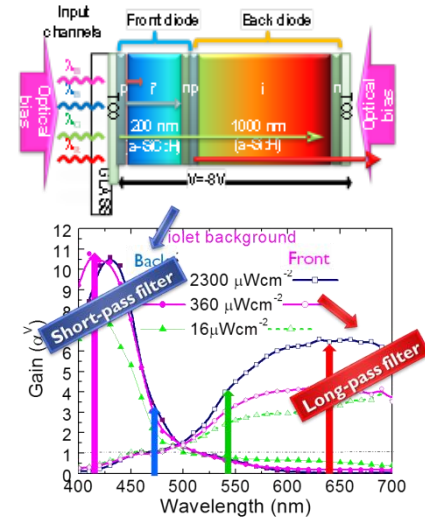

Indoor positioning system using a-SiC:H a WDM device



- The nonlinear property of SiC multilayer devices under UV irradiation is used to design an optical processor for indoor positioning.

VLC – Visible Light Communication

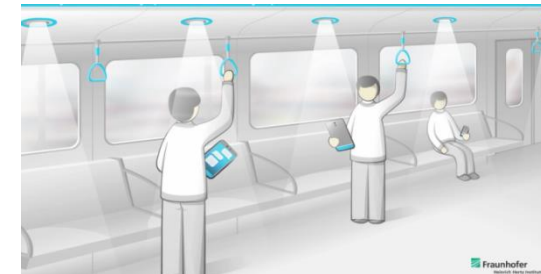
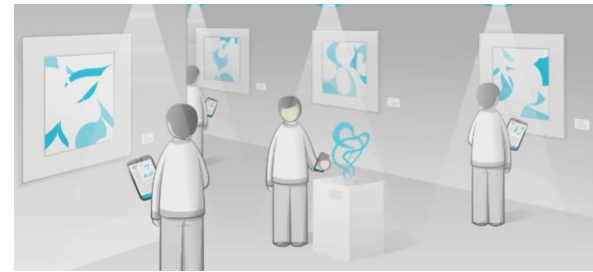

Indoor use:

- atmospheric absorption
- shadows
- light dispersion
- influence of other light sources

- Internet service distribution
- Navigation techniques

3 Gbps

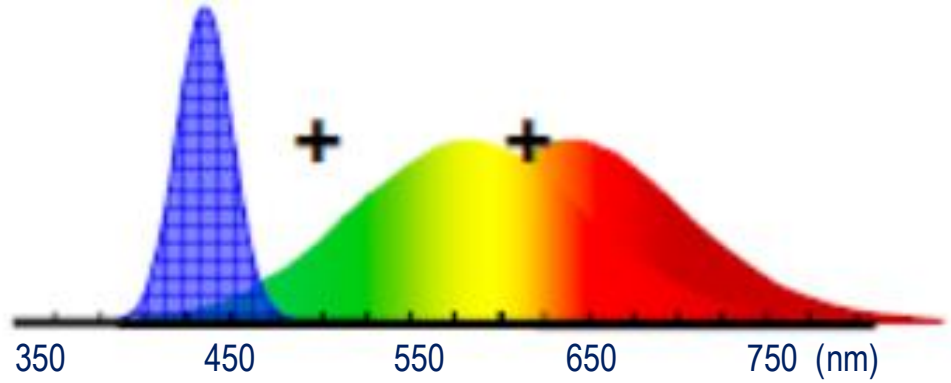
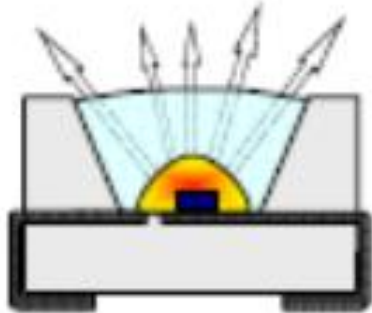

Blue LED with phosphor layer

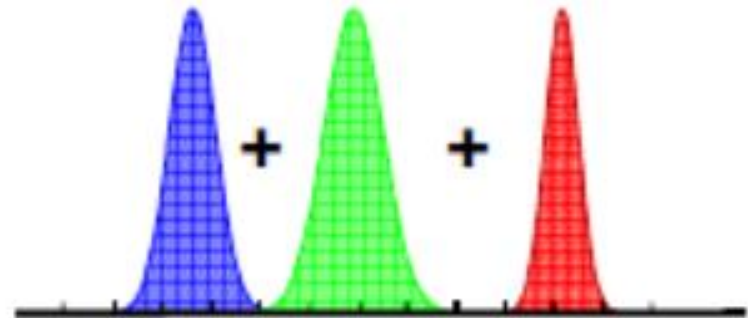
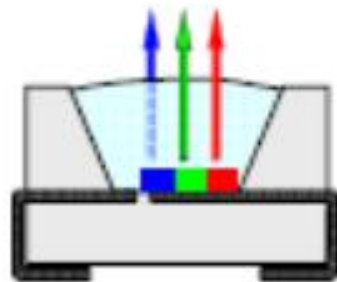

Red, Green and Blue LED

LEDS EMISSION SPECTRUM

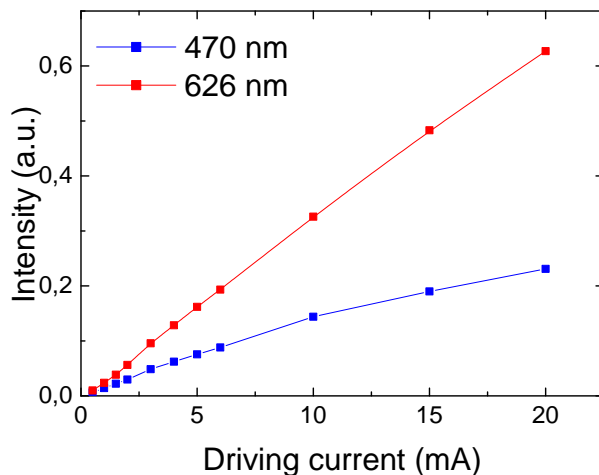
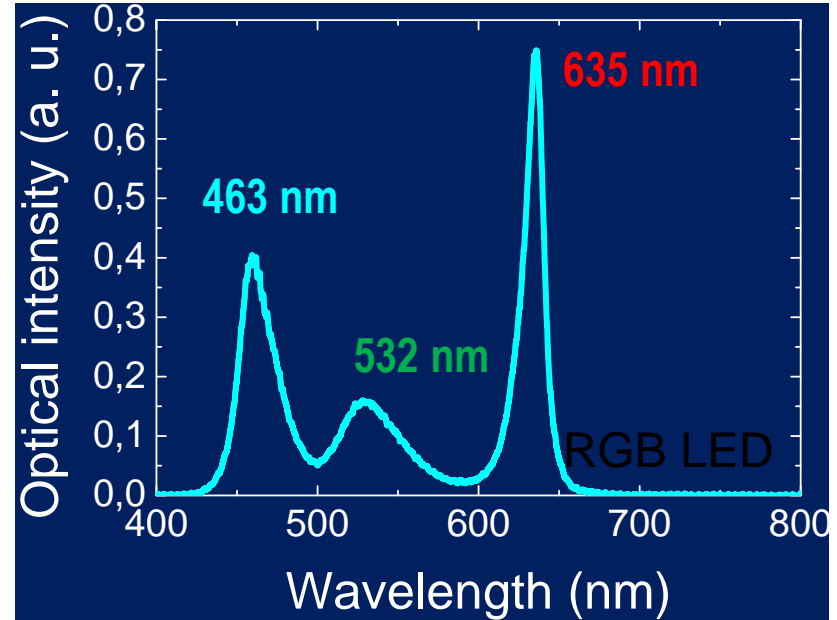
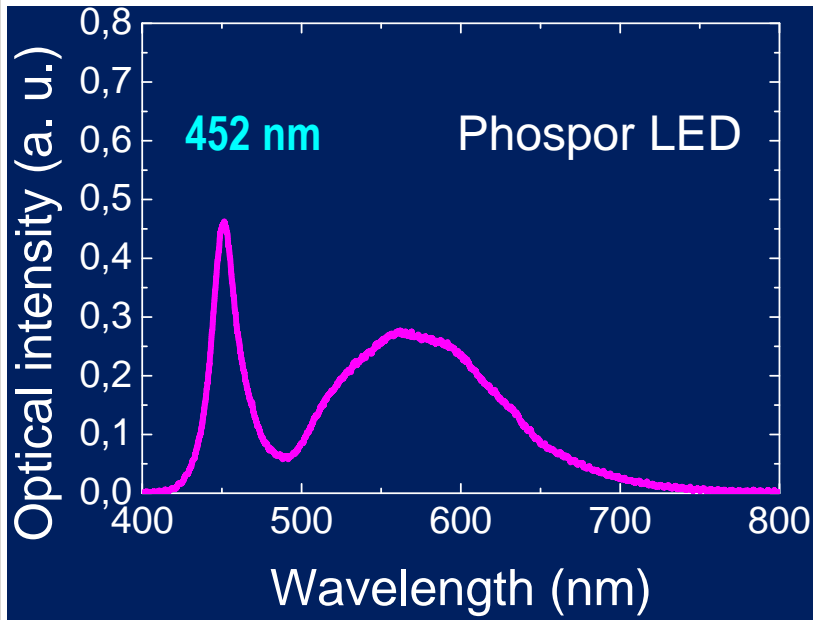

- The magnitude and width of each RGB peaks are optimized for the white.
- The green component is lowest because the human eye has a maximum sensitivity at 530 nm.

- The system is a self-positioning system in which the measuring unit is mobile.
- This unit receives the signals from several transmitters in known locations, and has the capability to compute its location based on the measured signals.

Transmitter

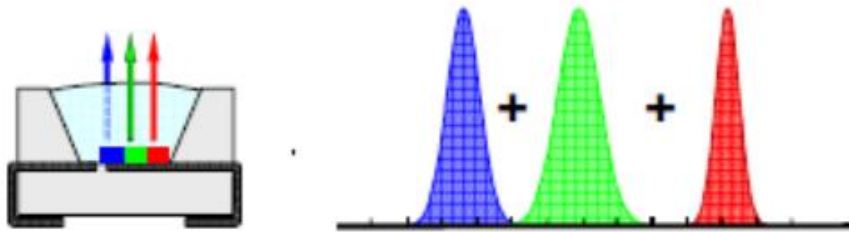

- Red, Green and Blue white LED

Receiver

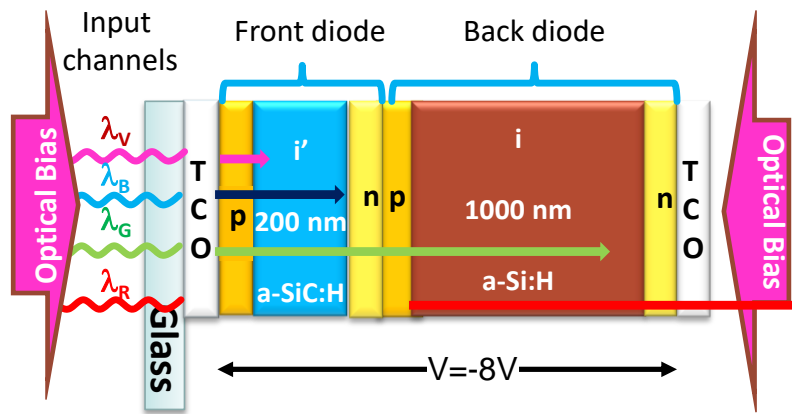

- p-i'(a-SiC:H)-n/p-i(a-Si:H)-n heterostructure produced by PECVD.

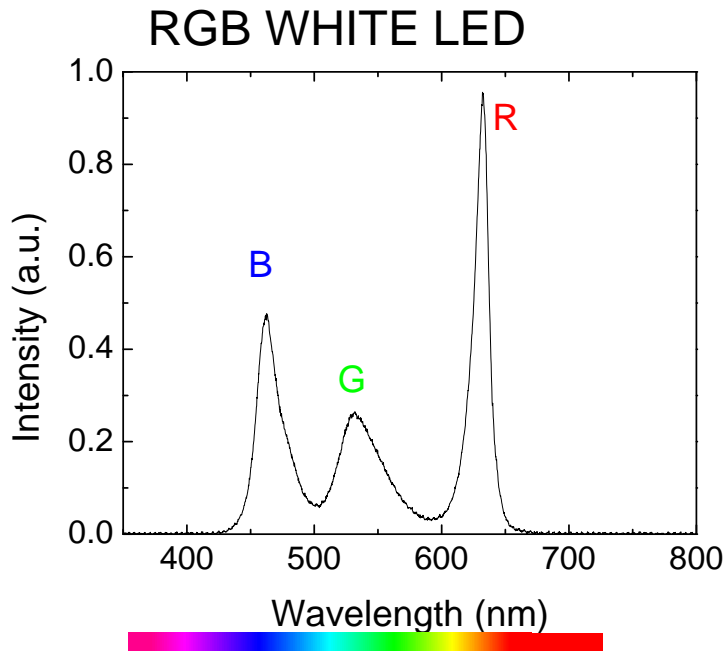

- The magnitude and width of each RGB peaks are optimized for the white.
- The green component is lowest because the human eye has a maximum sensitivity at 530 nm.

- The grid size was chosen to avoid data overlap in the receiver from adjacent grid points.
- The LEDs can be switched on and off individually for a desired bit sequence.

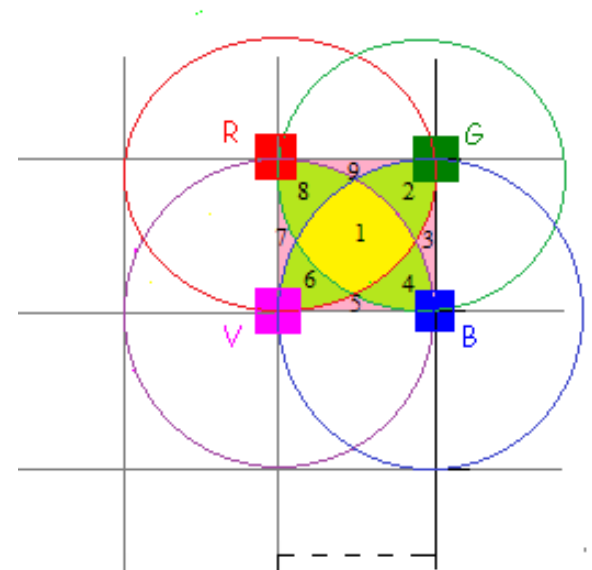

Nearest regions	1	2	3	4	5	6	7	8	9
Overlap	RGBV	RGB	GB	GBV	BV	RBV	RV	RGV	RG

Four channels transmission

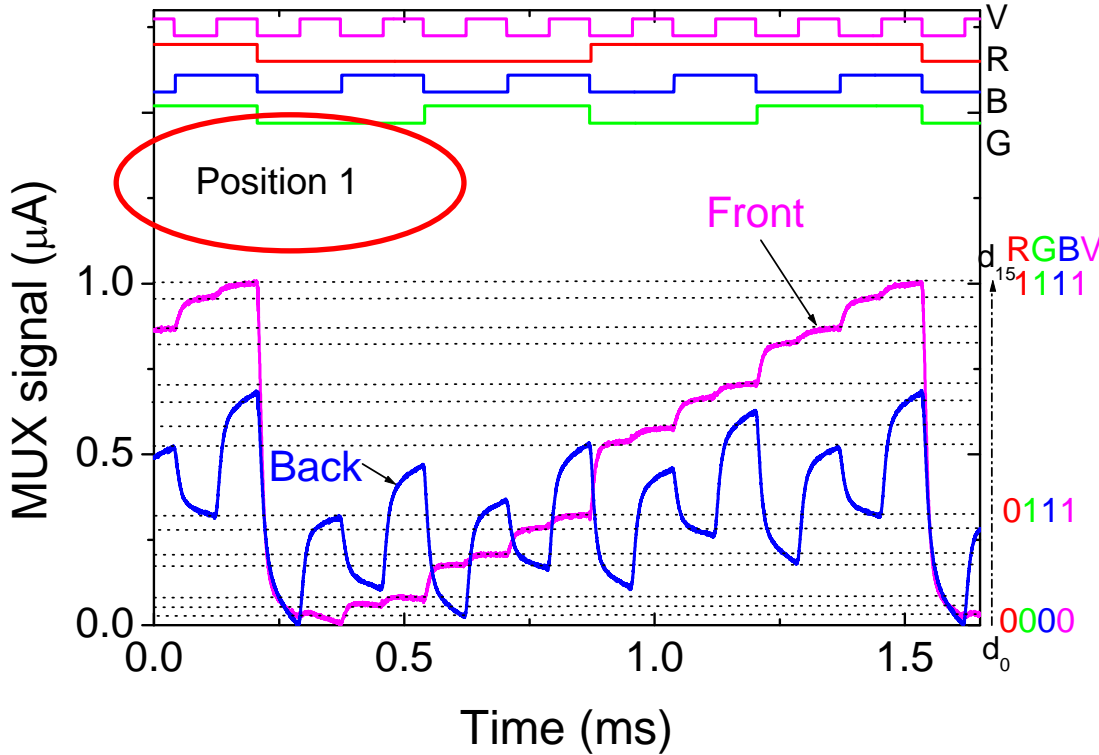

- 2^4 ordered levels pondered by their optical gains are detected and correspond to all the possible combinations of the *on/off* states.

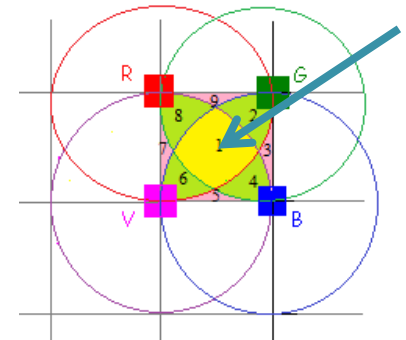

- Looking to the different levels, we have ascribed a binary code of 4 bits (RGBV) to each position, where 1 means that the channel is received and 0 that is absent .

POSITIONING MUX/DEMUX SIGNALS

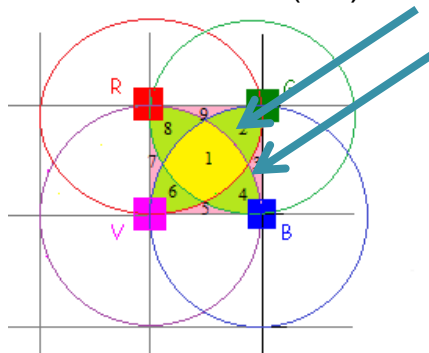
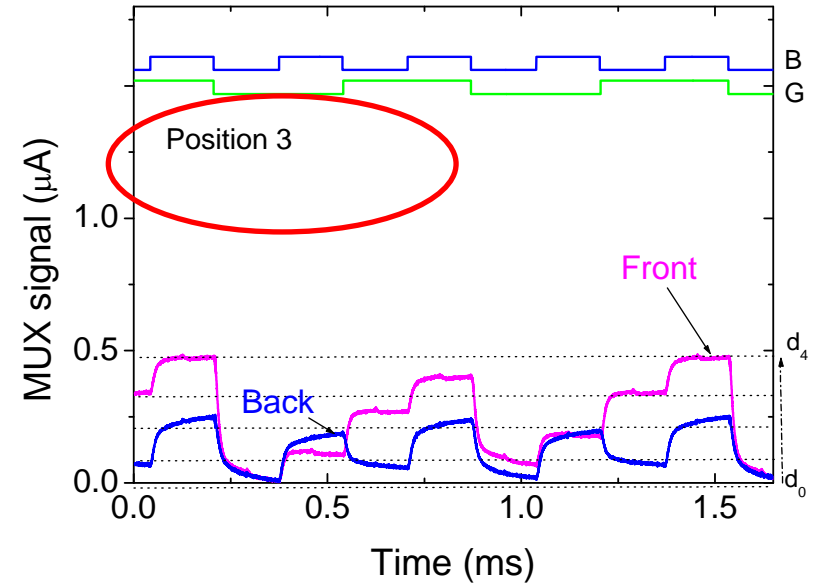
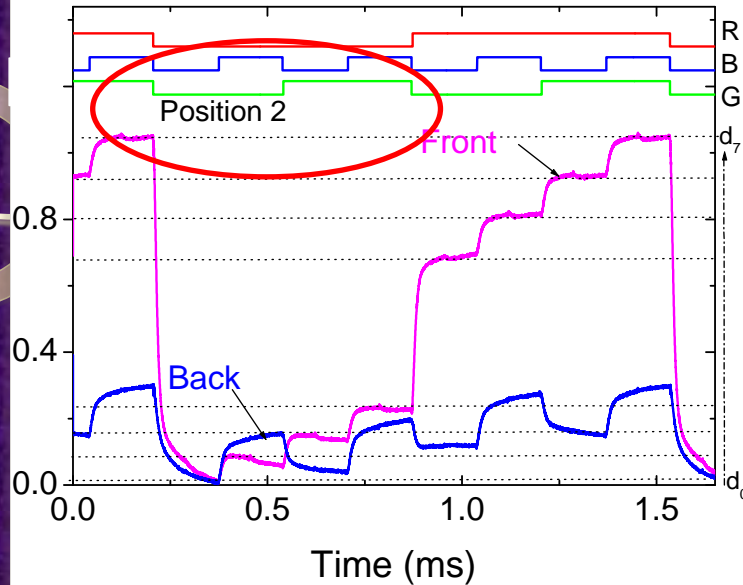

- A node requires only information about the locations of its neighbors, but not the other nodes in the network to make an initial estimate of its own location.

Nearest regions	1	2	3	4	5	6	7	8	9
Code position	1111	1110	0110	0111	0011	1011	1001	1101	1100
Parity position	111	000	110	001	010	100	001	010	101

NAVIGATION DATA BITS

MUX signal (μA)

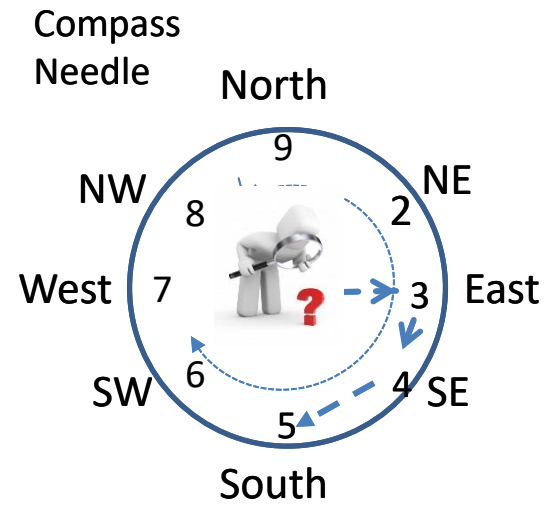
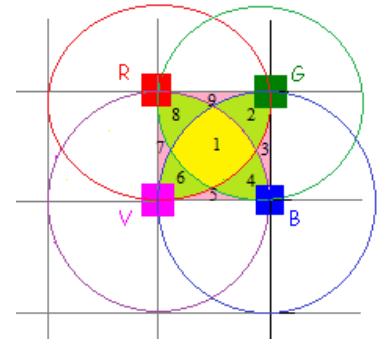
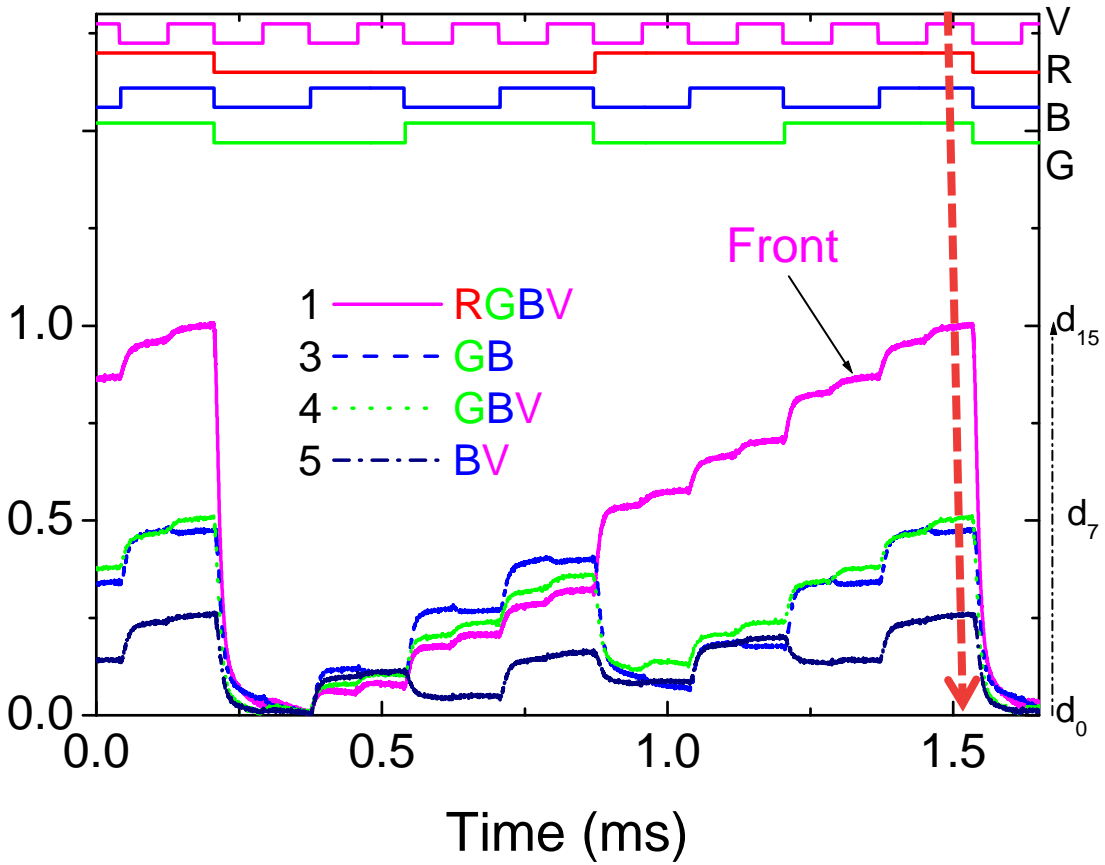

- For each transition between an initial location and a final one, two code words are generated, the initial (i) and the final (f). If the receiver stays under the same region they should be the same, if it moves away they are different.

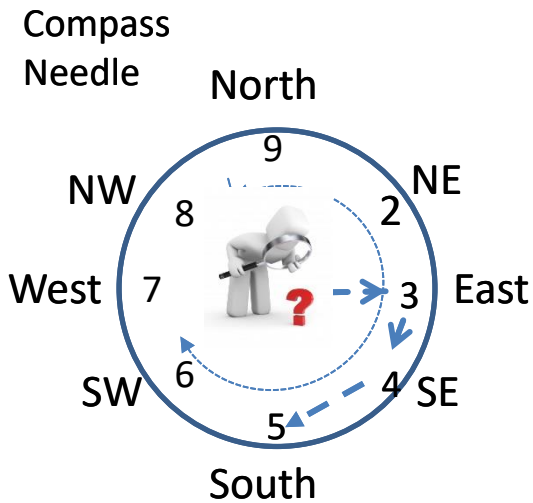

- At each regions the MUX signals present different pattern that after decoding give information about the mobile navigation and received information along the time.
- The device's position (ID position) during the receiving process will be given by the highest detected level (vertical dot line in the figures), *i. e.*, the level where all the n ($n=1, 2, 3, 4$) channels are simultaneously on.

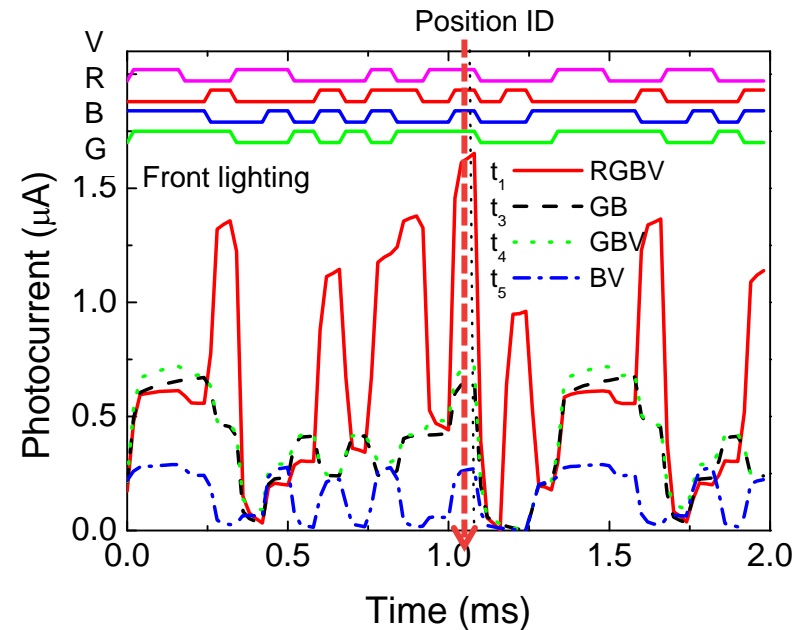
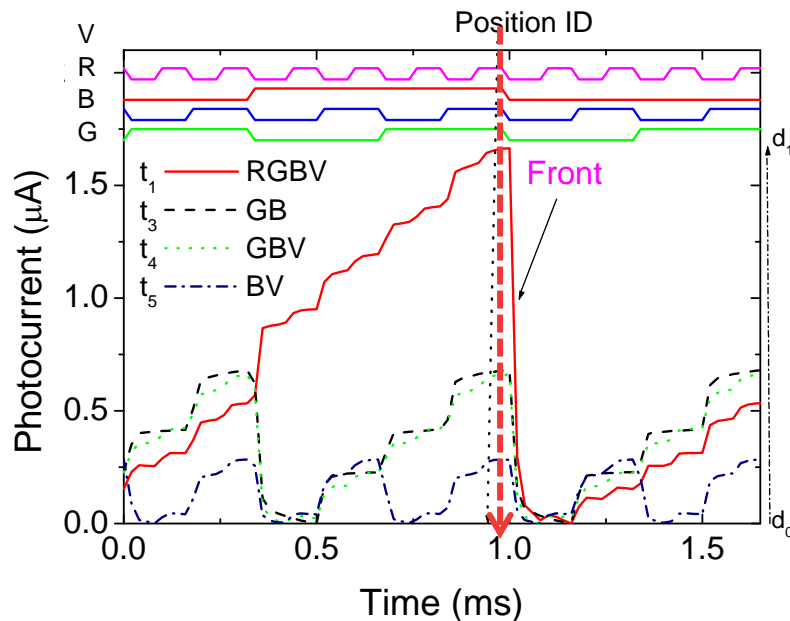

- VLC system characteristics for positioning on its different components such as the transmitter and the receiver, the multiplexing techniques, the visible light sensing and lastly, indoor localization and motion recognition were analyzed.
- The results showed that by using a pinpin double photodiode based on a a-SiC:H heterostucture as receiver and RBG-LED as transmitters it is possible not only to determine the position of a mobile target but also to infer the travel direction along the time.
- Future work will consider to improve the transmission rate through parallelizing communication by using multiple emitters and receivers.

Coupled Data Transmission and Indoor Positioning by Using Transmitting Trichromatic White LEDs and a SiC Optical MUX/DEMUX Mobile Receiver



- The system is a self-positioning system in which the measuring unit is mobile.
- This unit receives the signals from several transmitters in known locations, and has the capability to compute its location based on the measured signals.

Transmitter

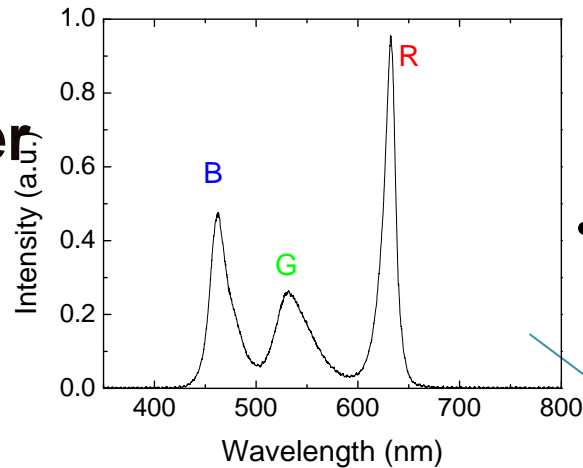
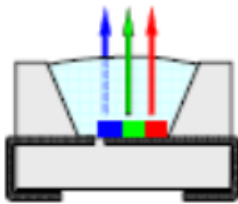

- Red, Green and Blue white LED

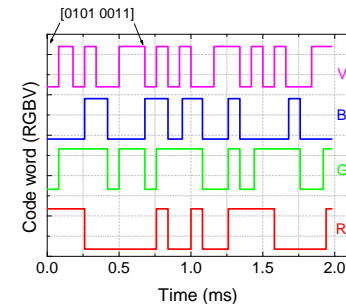

Receiver

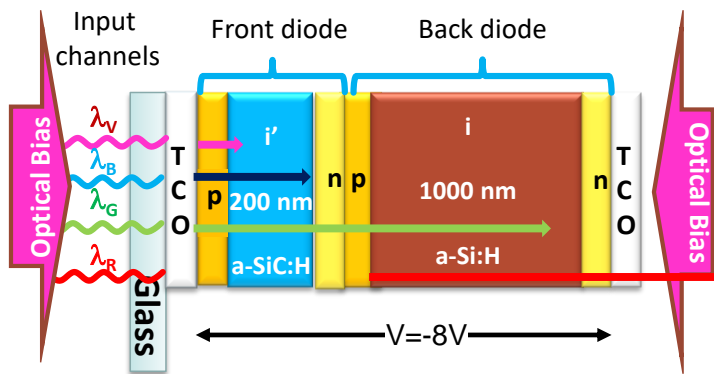

- p-i'(a-SiC:H)-n/p-i(a-Si:H)-n heterostructure produced by PECVD.

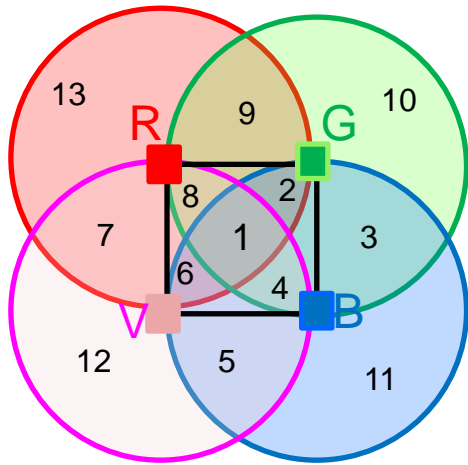

Square

- Four modulated LEDs (RGBV) located at the corners of a square grid.

Region	1	2	3	4	5	6	7	8	9	10	11	12	13
Overlap	RGBV	RGB	GB	GBV	BV	RBV	RV	RGV	RG	G	B	V	R

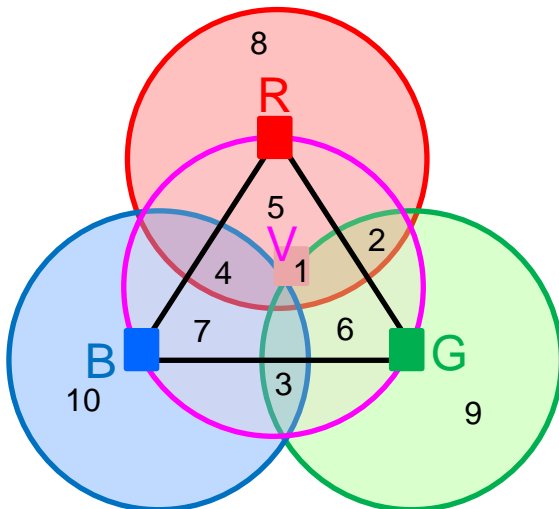

Triangular

- Four modulated LEDs (RGBV), three of them (RGB-LED) are located at the vertices of an equilateral triangle and a fourth one (V) is located at its centroid.

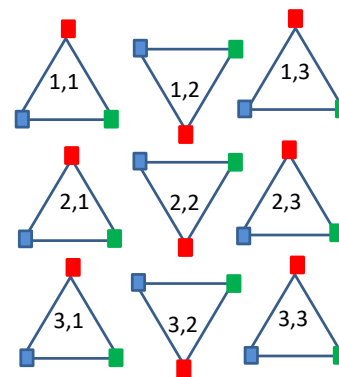

Region	1	2	3	4	5	6	7	8	9	10
Overlap	RGBV	RGV	GBV	RBV	RV	GV	RB	R	G	B

Receiver configuration and operation

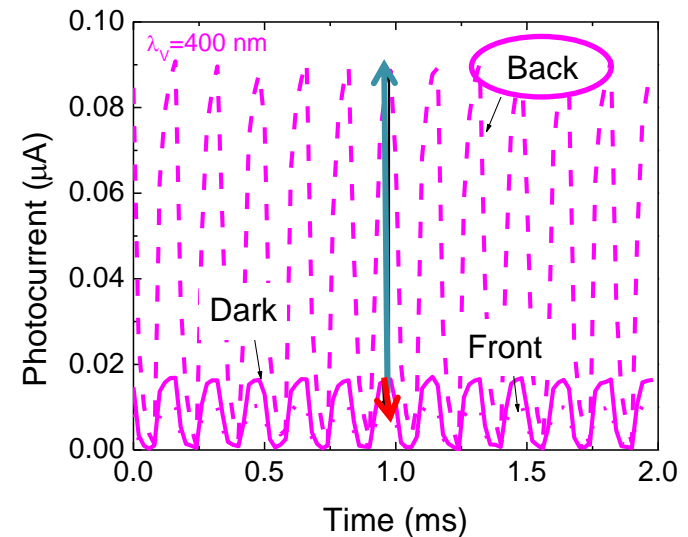
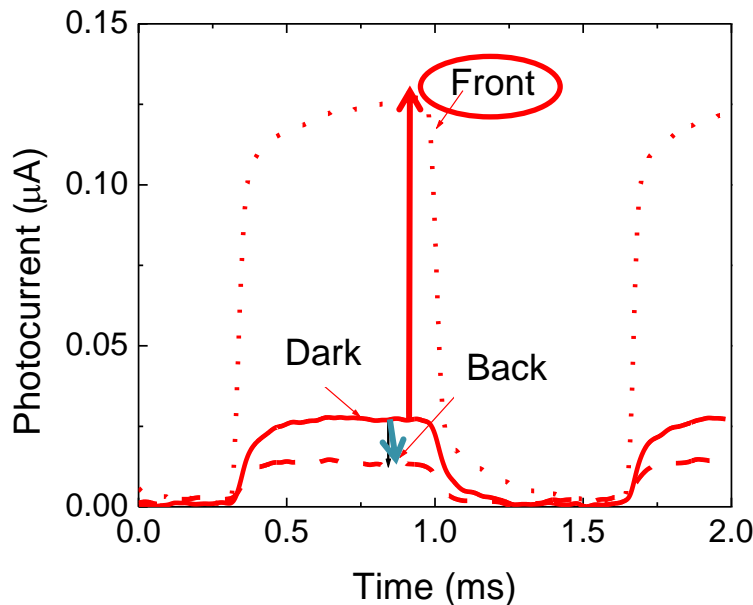
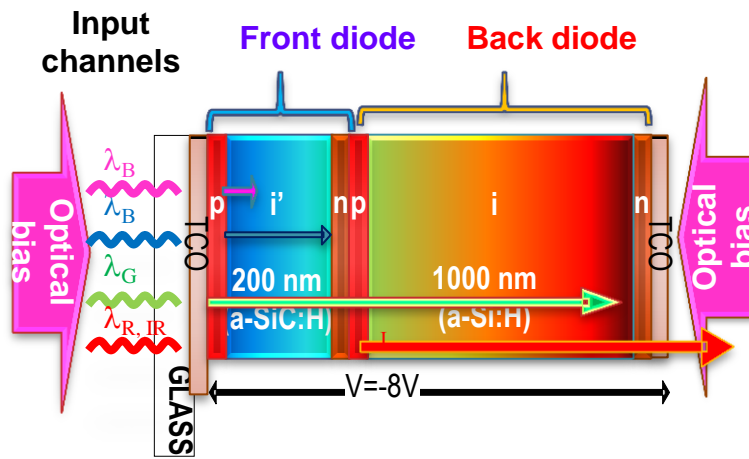

- Produced by PECVD

- The thickness of the front photodiode are optimized for blue collection and red transmittance

- The thickness of the back photodiode was adjusted to achieve high collection in the red spectral range

✓ Both front and back diodes act as optical filters confining, respectively, the blue and the red optical carriers, while the green ones are absorbed across both.

Transmitter / Receiver of VLC

LED

ID data transmit with fast blinking

Coder/decoder device

Bit decode

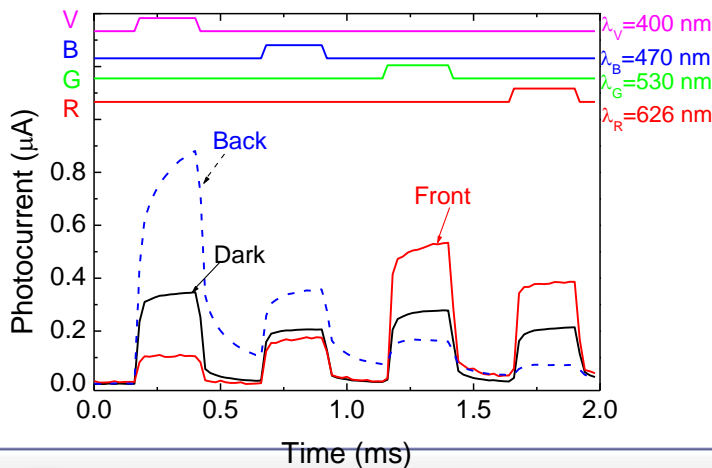
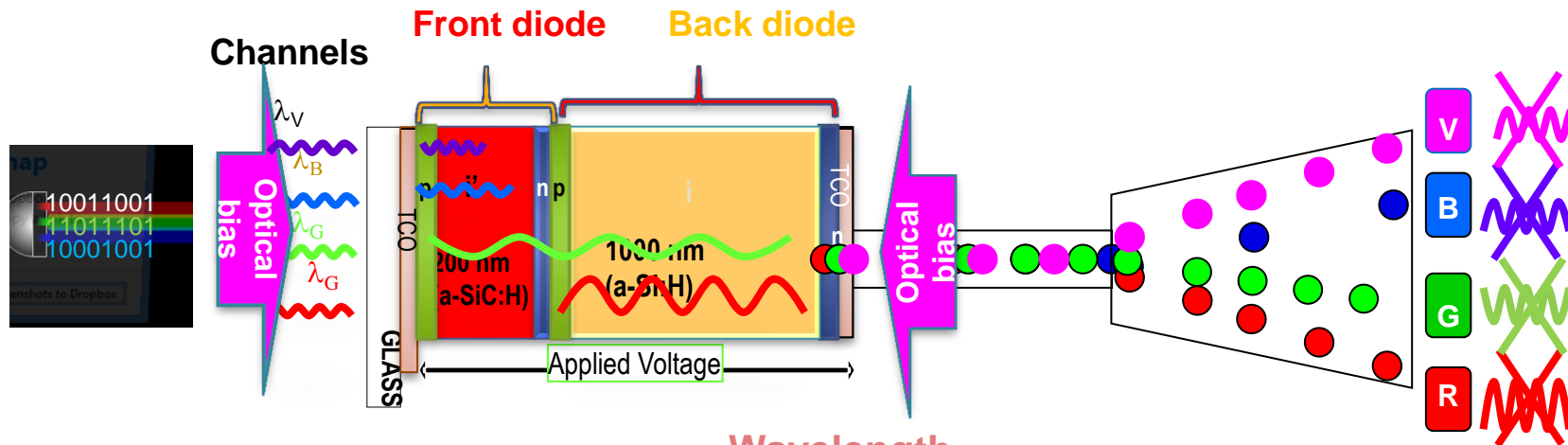

Wavelength
Division
Multiplexing

Wavelength
Division
Demultiplexing

- ✓ The input signals exhibits a nonlinear dependence on the wavelength.
- ✓ Gains ($\alpha^V_{R,G,B,V}$) at the input red, green, blue and violet channels.

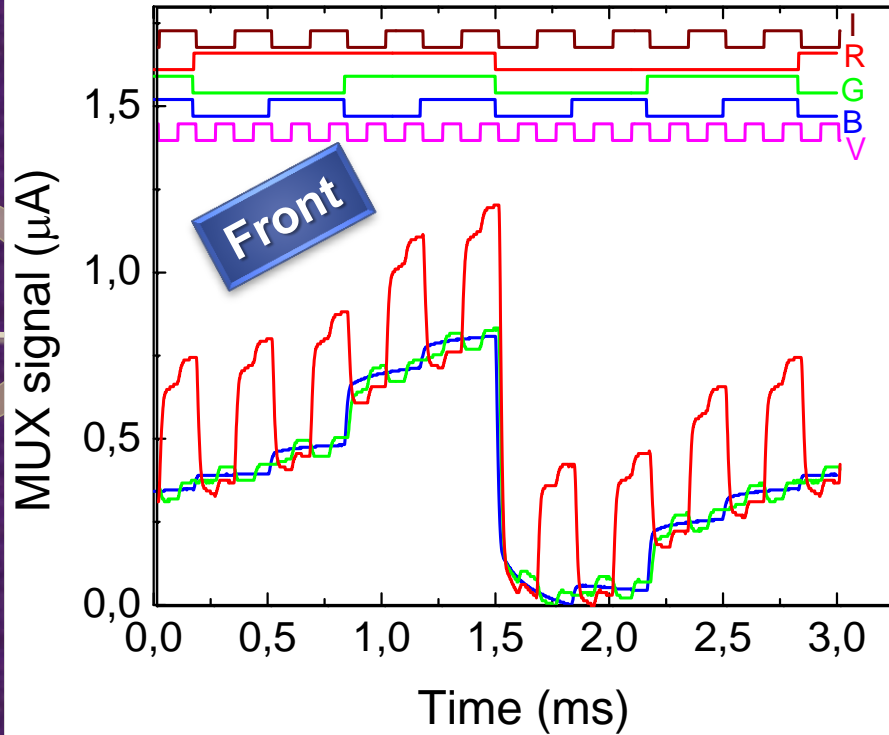

•The output presents 2^4 ordered levels each one related with **RGBV** bit sequences

•The output presents 2^3 ordered levels each one related with **RGB** bit sequences

•The output presents 2^5 ordered levels each one related with **RGBVI** bit sequences

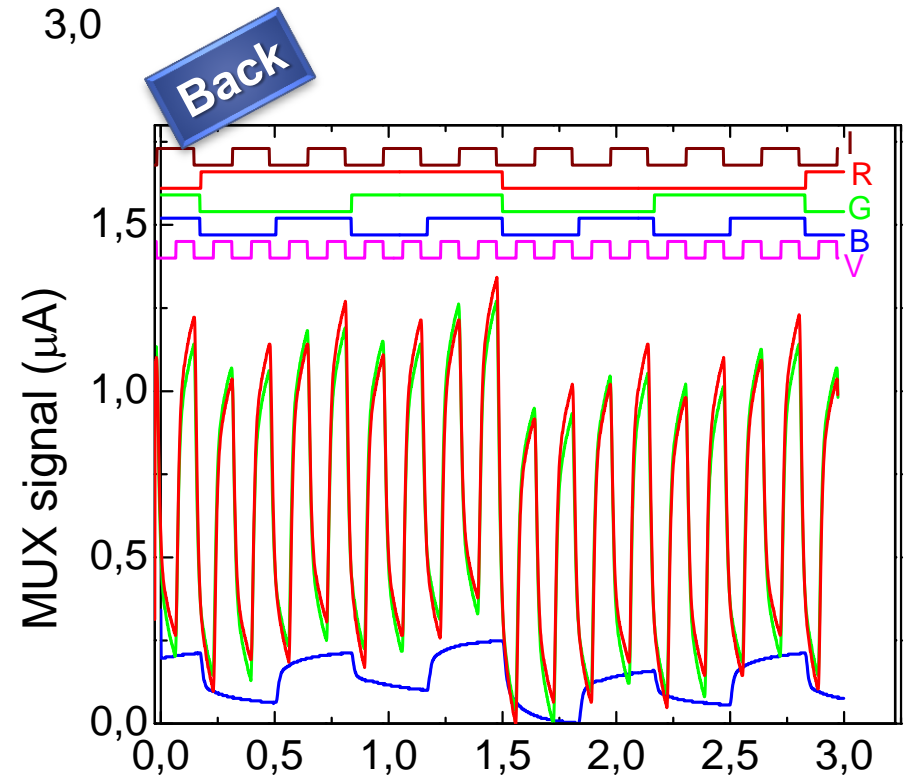

Square topology

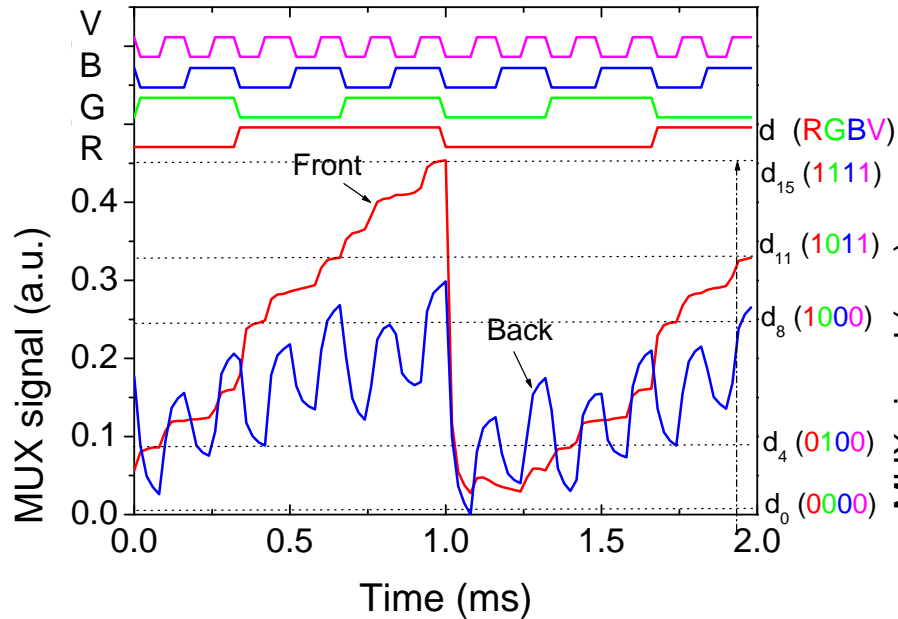

Triangular topology.

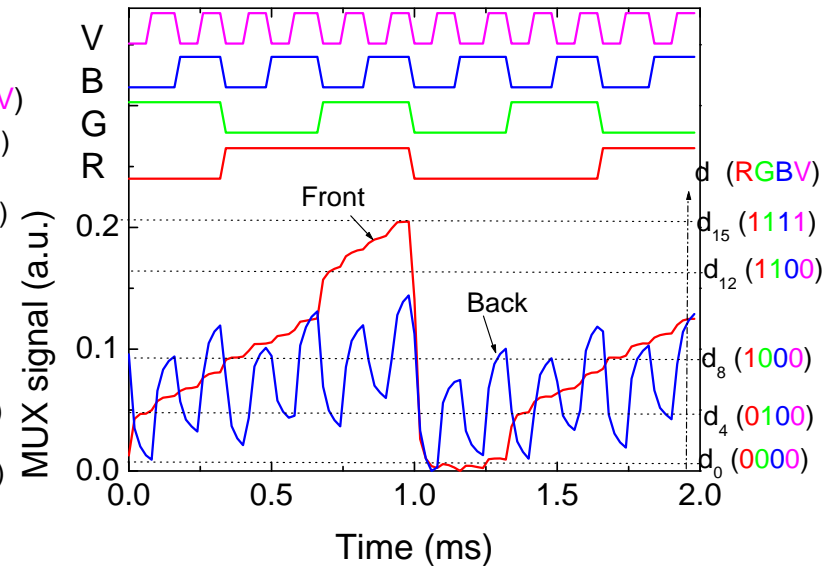

- 2^n ordered levels pondered by their optical gains are detected and correspond to all the possible combinations of the *on/off* states.
- The background acts as selector that chooses one or more of the 2^n sublevels, with n the number of transmitted channels, and their n -bit binary code .
- By assigning each output level to a n digit binary code the signal can be decoded. A maximum transmission rate capability of 30 Kbps was achieved.

POSITIONING MUX/DEMUX SIGNALS

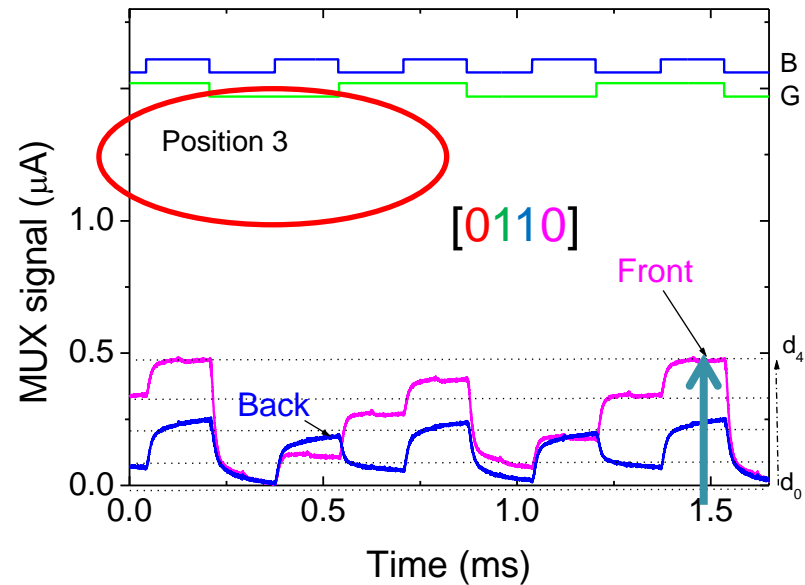
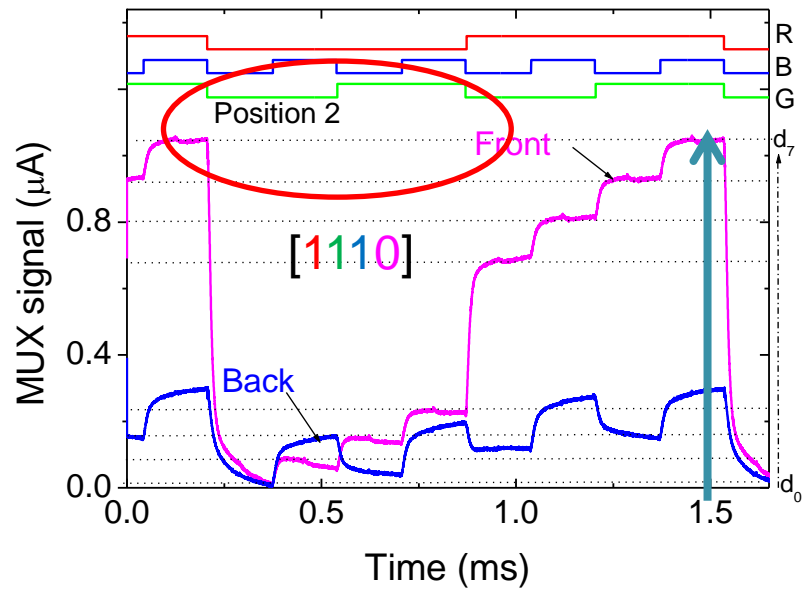
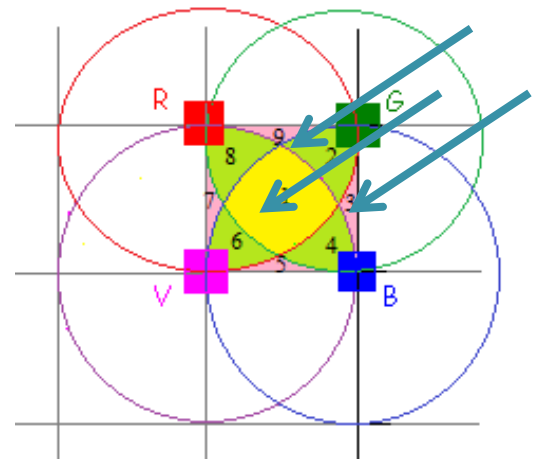
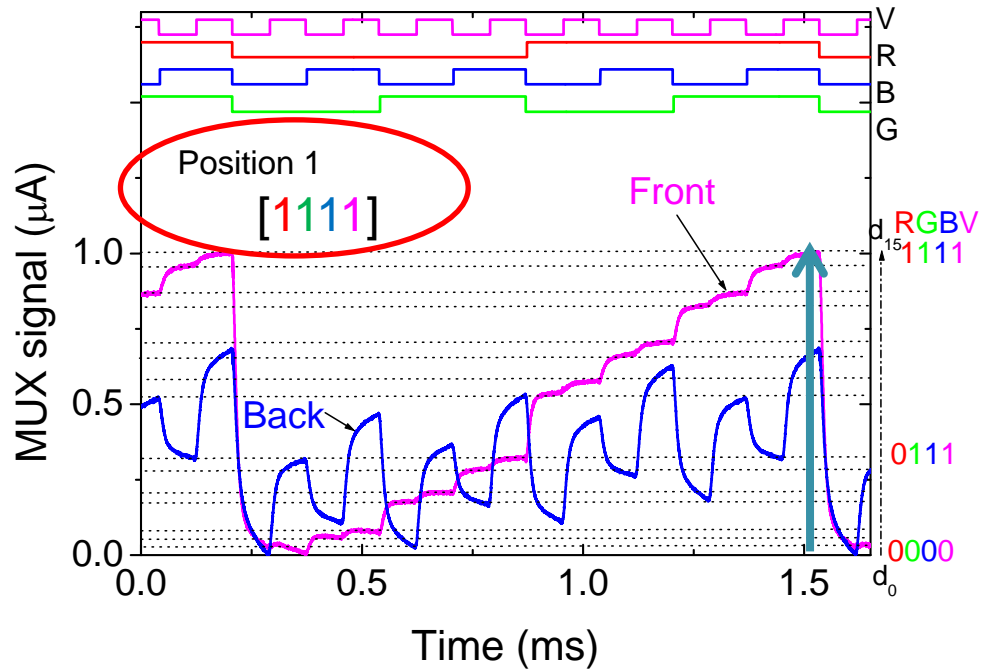

- Looking to the different levels, we have ascribed a binary code of 4 bits (RGBV) to each position, where 1 means that the channel is received and 0 that is absent .

POSITIONING

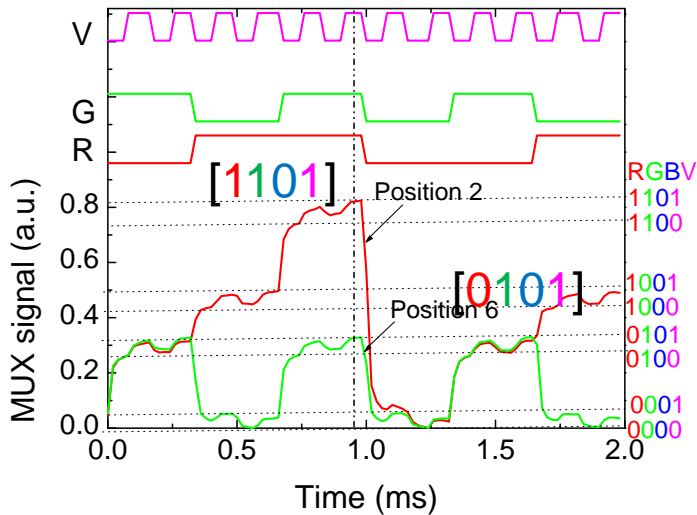
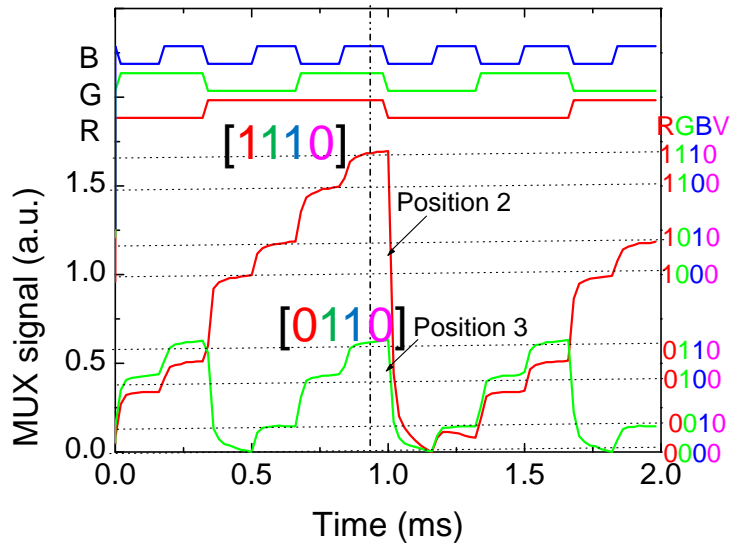

Square topology

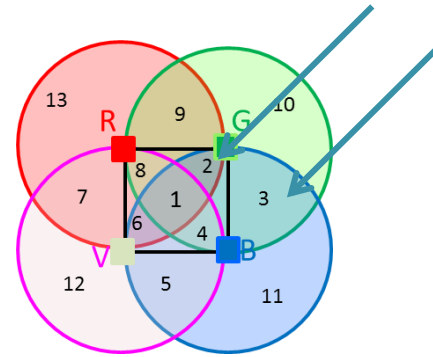

Triangular topology

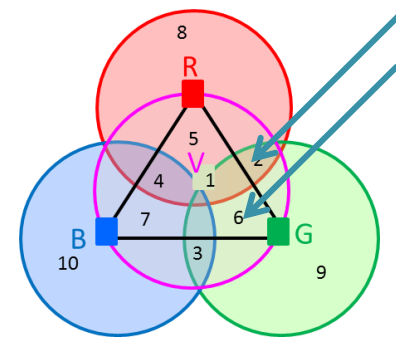

Nearest regions	1	2	3	4	5	6	7	8	9	10	11	12	13
Code position (Square topology)	1111	1110	0110	0111	0011	1011	1001	1101	1100	0100	0010	0001	1000
Code position (Triangular topology)	1111	1101	0111	1011	1001	0101	1010	1000	0100	0010	-	-	-

NAVIGATION DATA BITS

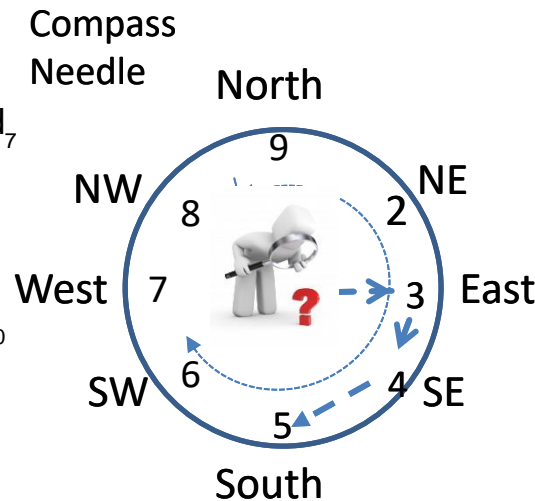
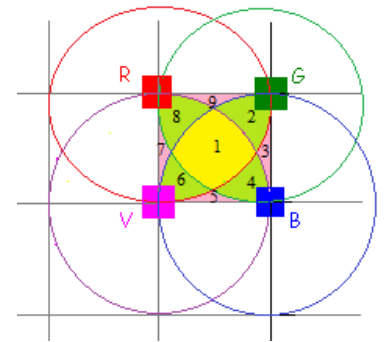
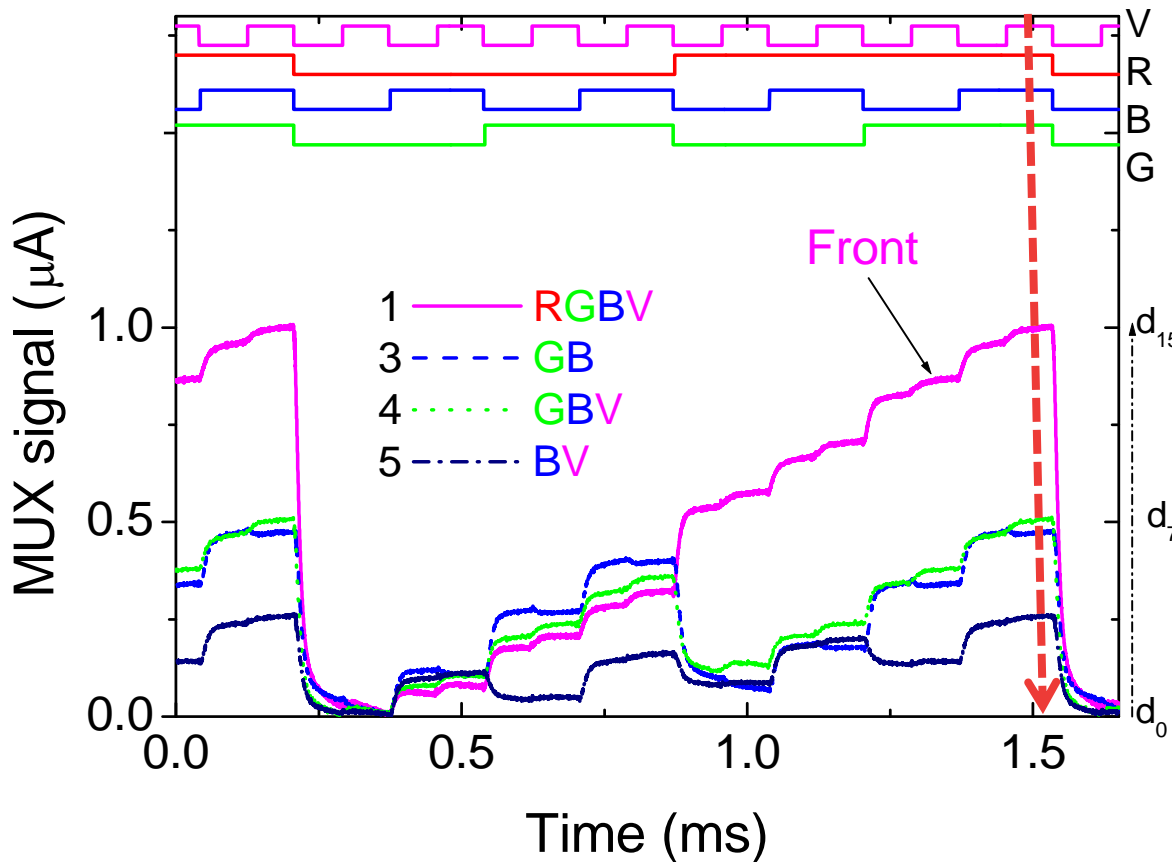

- For each transition between an initial location and a final one, two code words are generated, the initial (i) and the final (f). If the receiver stays under the same region they should be the same, if it moves away they are different.

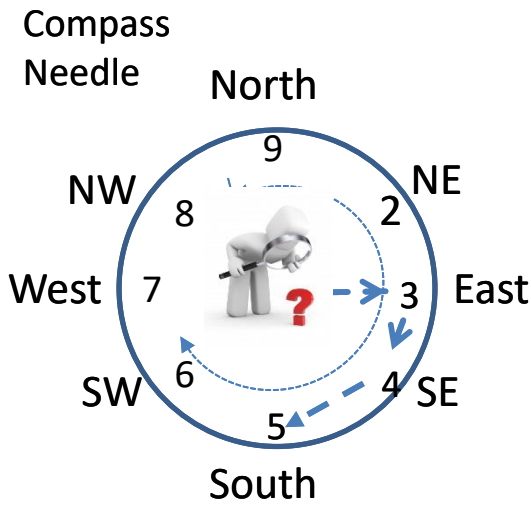

- At each regions the MUX signals present different pattern that after decoding give information about the mobile navigation and received information along the time.
- The device's position (ID position) during the receiving process will be given by the highest detected level (vertical dot line in the figures), *i. e.*, the level where all the n ($n=1, 2, 3, 4$) channels are simultaneously on.

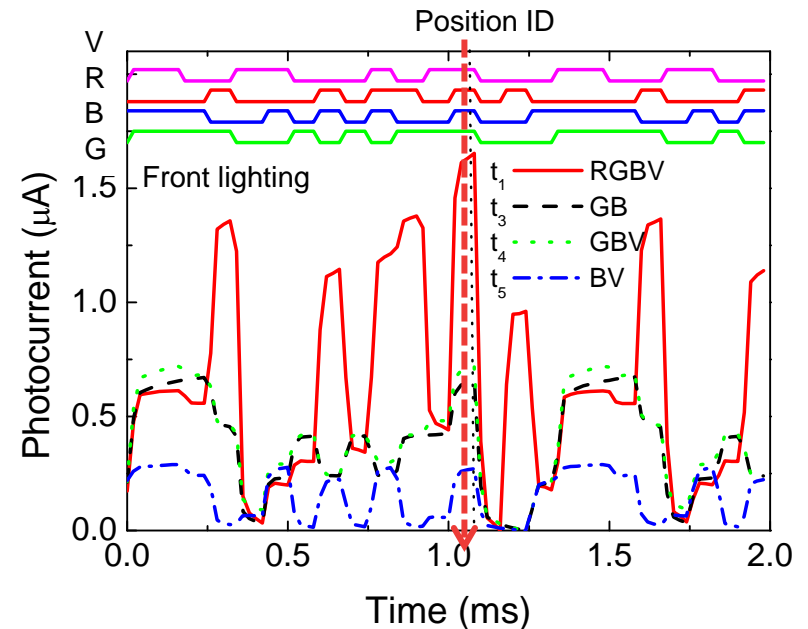
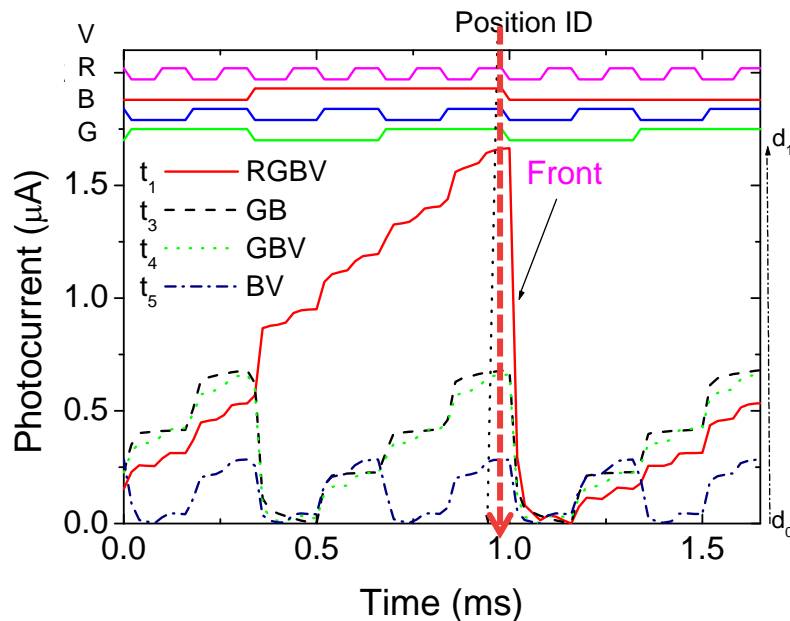

NAVIGATION DATA BITS

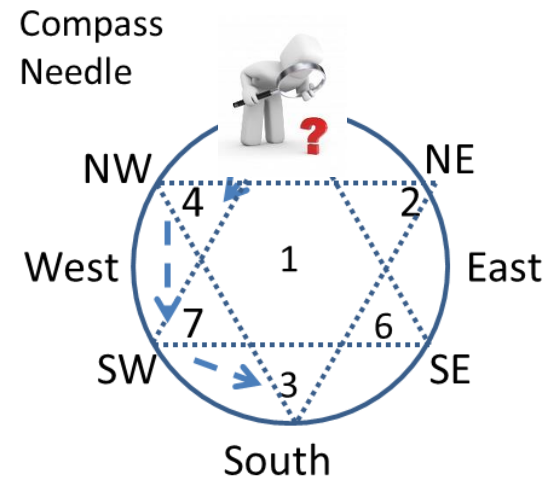
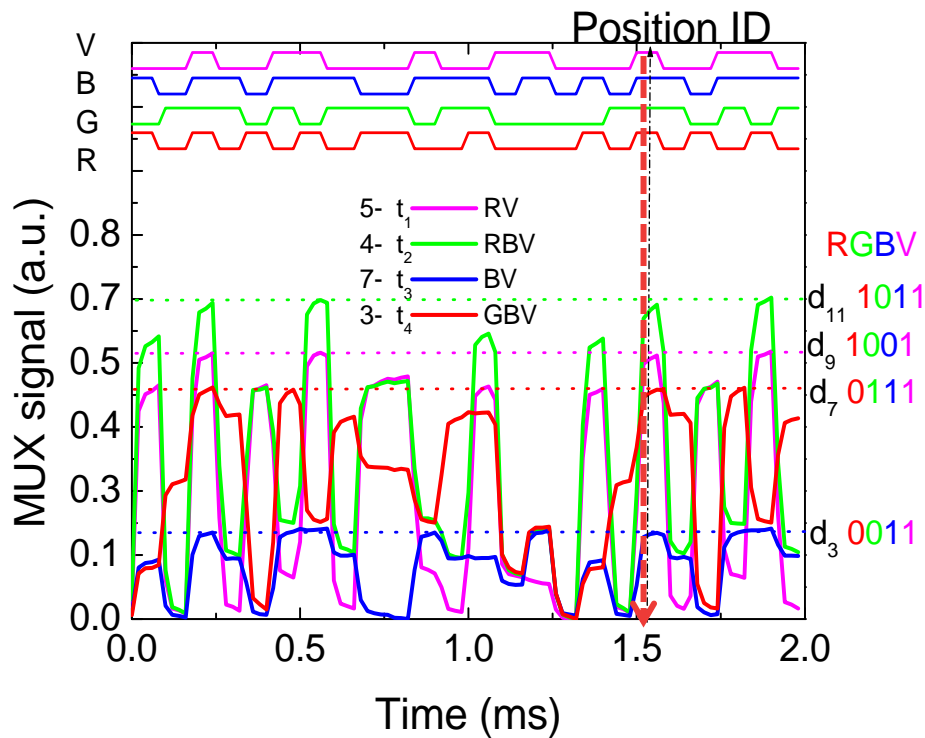
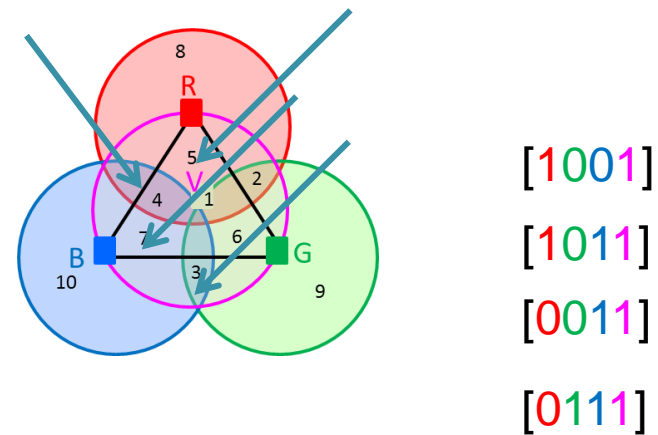
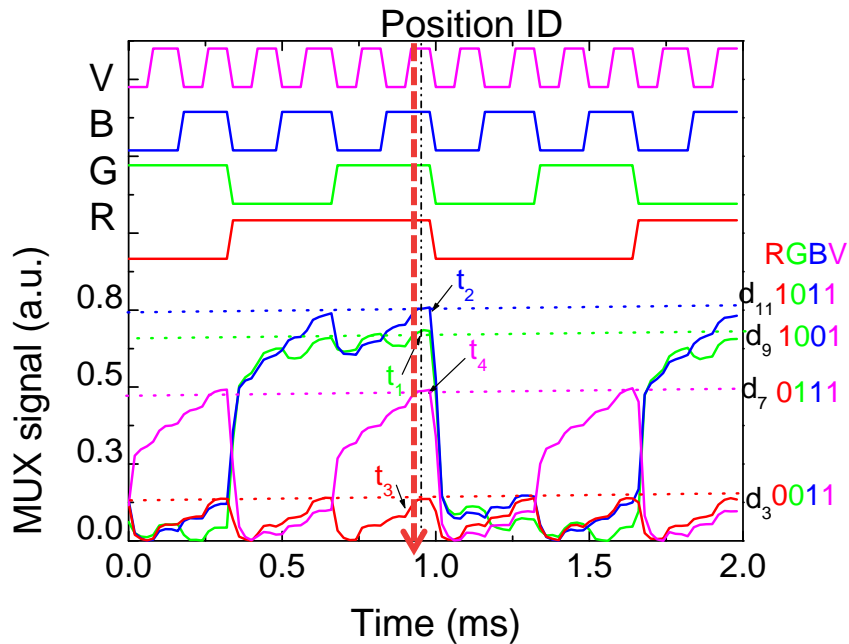

- The eight first bits of the violet packet give the 8-bit address of the unit cell

The 8-bit positioning ID decoded from the violet channel is: [0101 0101], which corresponds to line 5, column 5 of the network.

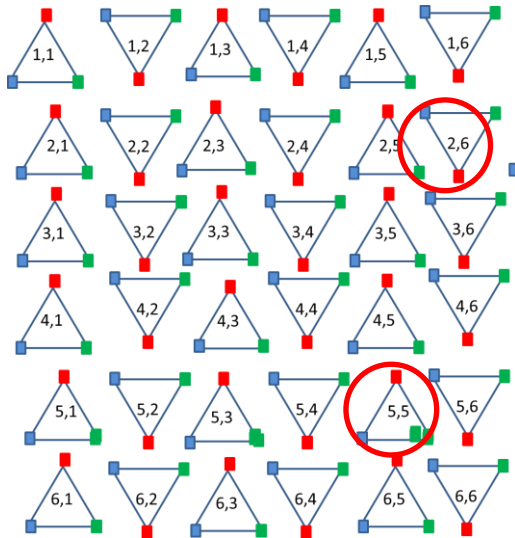

the 8-bit positioning ID decoded from the violet channel is: [0010 0110], which corresponds to line 2, column 6 of the network.

- The 4-bit code that corresponds to the ID position inside the unit cell is the same: Position 2 [1101] and Position 6 [0101] but the unit cell is different.

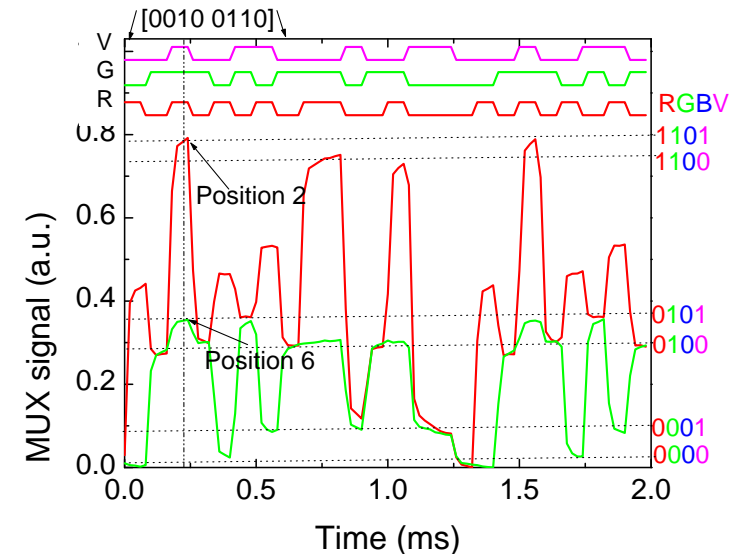
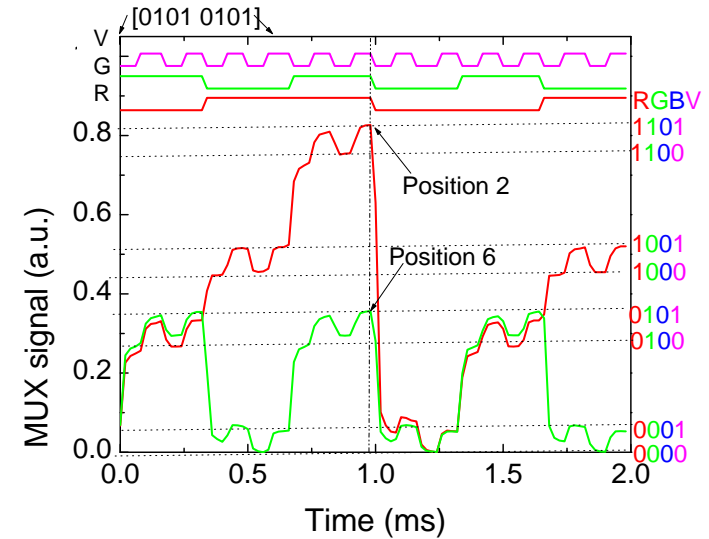

- A coupled data transmission and indoor positioning was presented. To transmit the data, an On-Off Keying code was used. A square and a triangular topology were considered for the unit cell.
- Fine-grained indoor localization was tested. A 2D localization design, demonstrated by a prototype implementation was developed.
- A detailed analysis of the characteristics of various components within the VLC system were discussed.
- Results showed it is possible not only to determine the position of a mobile target inside the unit cell but also in the network and concomitantly to infer the travel direction along the time.
- For future work, by using multiple emitters and receivers, the transmission data rate through parallelized spatial multiplexing can be improved.